



1

PHT  
FREE



1



2



7



3

### SINKER RING

The sand filled, weighted rings stand upright on pool floor for easy grabbing. Diving for these rings is not only fun, but it promotes underwater swimming skills and confidence in young children.

- 1 **57502** Fluorescent Color - Set of 4 in display pack.
- 2 **57503** Transparent - Set of 6  
Ideal for the Fun or life saving practice. Cannot be visible until very close up.
- 3 **57504** Graduated Dive Ring, Heavy duty nesting from 8" to 5". Set of 4 in display bag.

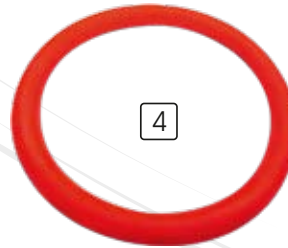

4



6

### DIVING RING

Rubber Construction. A simple toss of the rings will send them falling into the pool's depths.

- 4 **57521** Rubber 150mm. 110gms. Red
- 5 **57529** Synthetic 160 mm, 200 gms Colors : Red ,Blue, Green & Yellow Set of 4 in display bag.
- 6 **57526** 5 kg Diving ring for rescue teams on life boats. Solid Rubber Construction.

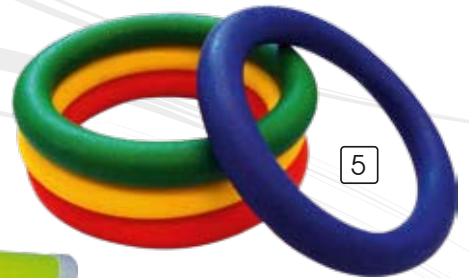

5

PHT  
FREE

### DIVING STICK

When being tossed into a swimming pool, sinks to the bottom while maintaining an upright posture so that it can easily be grasped by a diver. Helps increase breath endurance and underwater swimming skills To be used under adult supervision and in a water depth of at least 1.5m.

- 7 **57511** Numbered ABS Plastic Sticks - Set of 6 colors.



8



7

- 8 **57512** Numbered - Set of 6 colors in display bag.

These weighted sticks have a non-rigid soft profile to provide safe underwater fun. Bright colors and a soft profile make them easy to see and grab in the water.

### DIVING STICK - JUMBO

These sticks are larger and heavier than the conventional Diving Sticks.

- 9 **57513** Individually pack.



9



### DIVING BRICK

Rubber covered weight that is used for recreation and dive training. The rubber covering protects the swimming pool surface from damage. Available in different sizes.

Round edge. 7 lbs. Size: 9" x 4½" x 3½"

- 1 **57530** Black
- 2 **57531** Blue

Round edge. 3 lbs. - Size: 6" x 4" x 2½"

- 3 **57532** Red
- 4 **57536** Black

Rectangular shape solid rubber. 2 kg.

- 5 **57533** Size: 250 mm x 110 mm x 60 mm

OFFICIAL Dive brick. Black

- 6 **57539** 8¼" X 3¼" X 3¼" - 10 LBS

### DIVING OBJECTS

Bright Colored weighted Vinyl objects adding spice to underwater fun. The High Frequency welding with stitching keeps the weight filling intact. When tossed into the pool, they sink to the bottom.

Kids of all ages love racing to see who collects first.

- 7 **57581** Dive Frog
- 8 **57582** Dive Fish
- 9 **57583** Dive Star fish
- 10 **57584** Dive Flower

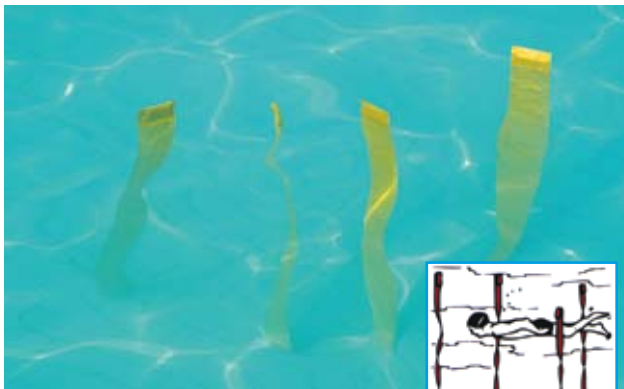

### EGG FLIPS

A novel aid in teaching the important aspects of breathing technique. Blow forcefully on the "egg" at water level and over it flips. The two color design ensures good visibility.

- 11 **57553** Set of 10 in display bag.

### UNDERWATER SLALOM

150 cm long laminated strips sewn up with ballast on one side and foam on the other. The lighter side floats up creating a seaweed effect. Swimmers can create a slalom course with one or more sets.

- 12 **57577** Set of 4 in display bag.

### DIVING FISH

Fish shaped rings create interest for kids. The fish are weighted and made from a durable and dense plastic. Stands upright on pool bottom.

- 13 **57591** Set of 6 in display bag.

### DIVING DISC

Color coded and numbered weighted disks, offering another interesting alternative as a diving product.

- 14 **57592** Set of 6 in display bag.

### DIVE ROSE

- 15 **57651** Sinks to the bottom of the pool.

### PEARL DIVING

A fun game consisting of 5 white pearls and 1 black pearl.

Toss the pearls into the water and whoever comes up with the black pearl is the winner.

- 16 **57593** Pack of 6 in display bag.



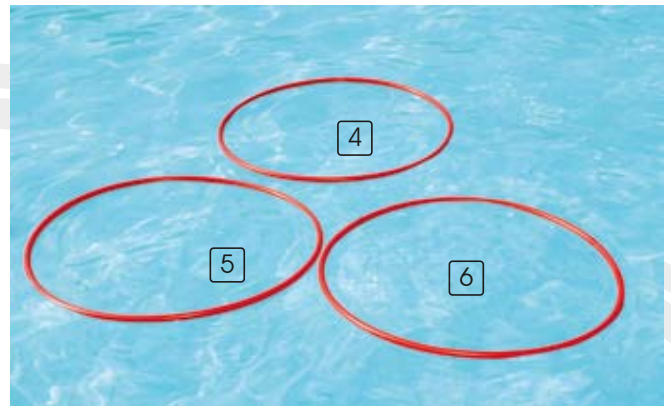
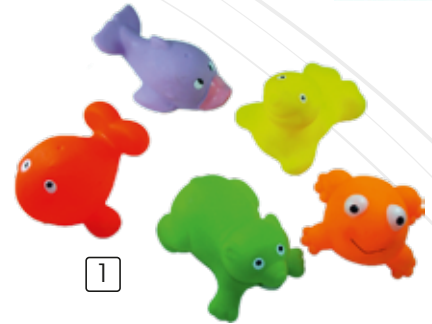

### FLOATING TOYS

- 1 **57664** Great fun in the pool or bath. Besides floating, the toys make a squeaking sound when squeezed. Yellow Duck, Purple Whale, Orange Crab, Blue Shark, Teddy in red. Set of 5.

### FLOATING RINGS

- 2 **57667** Sponge rubber, soft and flexible. Approx. 190 gms.

### FLOATING DISC

- 3 **57668** Floating disc set for ludo-didactic activity. Soft Rubber in 4 Team colours.

### FLOATING HOOPS

Light weight hoops, suited for teaching and free playing. Welded waterproof, no gluing points.

- 4 **57561** 610mm  
5 **57562** 760mm  
6 **57563** 915mm



### BACKSTROKE FLAGS - Nylon

Heavy duty nylon Flags sewn on polyester tape. Extra length of tape on ends for fastening. Custom Made as per the specifications provided.

- 7 **57661** Available in assortment of Red, Blue & White.  
8 **57662** Yellow & Black with logo printed.

### HOOP + WEIGHT

30" Hoops with weighted bag. The adjustable rope allows different height settings for underwater fun.

- 9 **57580** 760mm hoop with weighted bag.

### WEIGHTED HOOPS

Great fun for learning and playing. Sink to the bottom of the pool. Ideal for creating a underwater race course.

- 10 **57571** 760mm, Available in Assorted Colours.

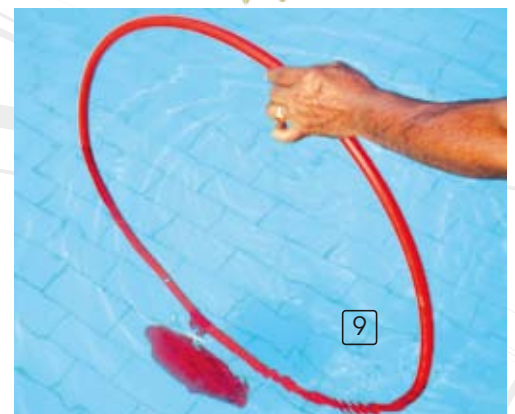



3

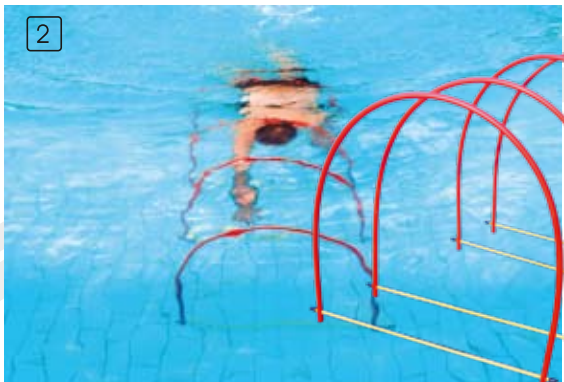

2



4



5



6

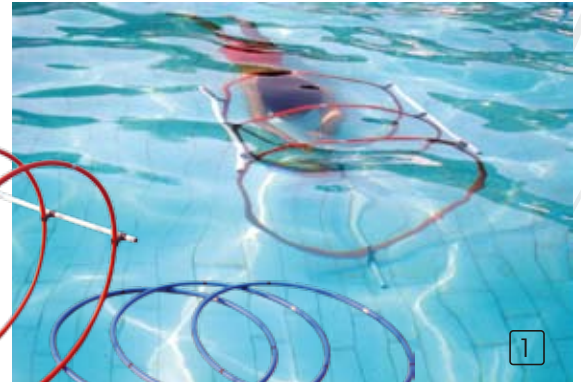

1

### WEIGHTED HOOP SET

With the use of 3 connecting bars and swivel clips, an adjustable length tunnel can be formed. Red hoops sink to the bottom, blue hoops float just below the surface.

- 1 **57590** Set consists: 3 Red hoops (weighted) + 3 Blue hoops, 3 connecting bars & 11 swivel clips.

### STAND UP HOOP SET - SLALOM DIVING

Special Hoop design with weighted crossbar on lower surface. The tires stand without further weights perpendicularly on the bottom.

- 2 **57611** Set of 4.

### WATER BASKETBALL GOAL - STANDARD

The three foam supports keep the hoop above water while you dunk, slam or jam the basketball. Fun for all ages.

- 3 **57574W** Basketball goal with ball.
- 3 **57574** Basketball goal.

### WATER BASKETBALL GOAL - LARGE

A larger water Basketball goal, easy to assemble with 915mm base for extra stability.

- 4 **57575W** Basketball goal with ball.
- 4 **57575** Basketball goal.

### WATER SOCCER GOAL ALUMINUM

Light constructed tubular aluminum with net. Fun for the pool or ideal for learning the skills of water polo. **Ball not included.**

- 5 **57622** Size: 965 x 710 x 610mm

### WATER MINI SOCCER GOAL

Lightweight tubular plastic, built of strong construction, requires assembly. Game is stable in the water and offers excellent value

- 6 **57641** Size: 900 X 700 X 600 mm

### WATER VOLLEY BALL GOAL

Lightweight tubular plastic, built of strong construction, requires assembly.

- 7 **57642** Size: 1860 X 1000mm



7



1

### WATER POLO PENALTY CARDS

1 **57645** Set of two cards: 1 Yellow + 1 Red-10X8 cm.

### WATER POLO REFEREE FLAGS

Heavy duty flag. Light weight handles.

2 **57647** Set of three: 1 Red + 1 White + 1 Blue

3 **57648** Empire Flags. Yellow



2-3

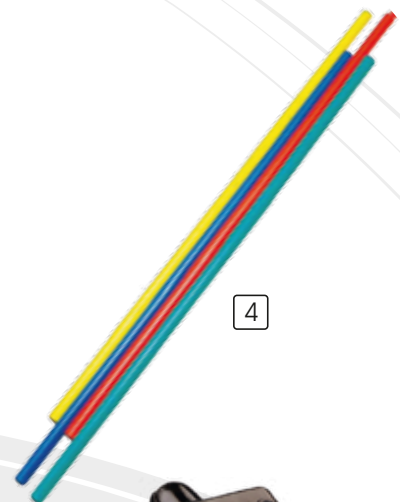

4

### GYMNASTIC WAND

Floating Heavy Duty Gymnastic wand, 1 Meter.

4 **57608** Color: Red, blue, yellow, green



6



5

### CLASSIC FOX 40 WHISTLE

5 **57653** High pitched unique Original whistle.

### STANDARD WHISTLE

6 **66305** Black with plastic ball inside so no impact on sound when used in water.



8

### BALLASTED STICK

7 **57601** Sand filled 50 cms long. 170g

7 **57602** Sand filled 100 cms long. 300g



7

### LIFE SAVING ROPE

Polypropylene rope 8mm.

8 **57703** Orange, 17 meters.



9

### SAFETY THROW BAG

9 **57704** 15m multi filament polypropylene rope bundled in a Compact bag. The bag can be worn around the waist.

### AQUA FITNESS

10 **57610** 1 Meter Heavy stick with rubber cord for Aqua exercise.

### HORSESHOE LIFEBOUOY

Soft cell foam. Orange

11 **57702** Size: 560 x 500 mm



11



10



1



2



3



4



5



6



7

**MESH EQUIPMENT BAGS**

Range of mesh bags in various sizes for swimming and storage. Ideal Ventilation for swimming articles.

- 1 **57636** Small: 300 x 375 mm
- 1 **57637** Medium: 450 x 750 mm
- 1 **57638** Large : 915 x 1150 mm

**TEAM BAGS**

- 2 **57634** Strong handles, Very spacious. Size: 77 x 45 x 40 cm
- 3 **57635** Adjustable shoulder strap Size: 107 cm length, 26 cm dia.

**SPORTS BOTTLES**

Top quality Sports Bottles in Team colors.

- 4 **57655** With Fluid Level Gauge on side. Easy to open Screw lid.
- 5 **57656** Vectra Large. Quick release drinking nozzle prevents spillage.
- 6 **57657** Sporty XL with auto cap.
- 7 **57658** Sporty Small with auto cap.

**FIN MESH BAGS**

- 8 **57633** Mesh Carry Bag With Drawstring Holds 1pr of Fins, Fits fins of all sizes.

**MULTI PURPOSE CARRY BAG**

- 9 **57632** 650 X 850 mm Strong mesh bag. White/Black. (Items in Bag not included)

**PE TEAM BASKET**

- 10 **57654** Plastic coated wire storage basket easily carried and ideal for pools. Size: 535 x 355 x 270mm.

**SWIM BOARD**

- 11 **57658** Floating Board, durable Plastic for swim Practice. Size : 400 x 280 x 38 mm.



9



8



10



11



1



2



3



4



5

### ARM BANDS FOAM

- 1 **57714** Pair of ankle and wrist bracelet, solid foam. Tough and durable and has a long life.

### SWIM BELT-BABY

- 2 **57718** The blocks tie around the chest allowing complete freedom of limb movement.

### BACKSTROKE TURNING POINT INSTALLATION

- 3 **57701** Backstroke warning kits to suit the width of your pool. Set of 4 Aluminium poles.

### FALSE START

- 4 **57705** False start installation, Set of 2 aluminium posts.

### FALSE START ROPE

- 5 **57710** Sectional Red floats - 12.50 meters with 11 Donuts & fixing snap-hook.  
5 **57711** Sectional Red floats - 16.50 meters with 15 Donuts & fixing snap-hook.

### WATER POLO CAPS

100% Stretch polyester with ear guards and has multiple holes to allow sound in and for increased water drainage. Numbered 1-21 with #1 quartered goalie caps.

Sets available in : Black, Green, Navy Blue, Royal or White.

- 6 **57715** Numbered on three sides of cap.  
6 **57716** Numbered on two sides cap.

### MULTI TRAINING ROLL

- 7 **57720** 10cm diameter, 107 cm in length for all in one training.

### WATER POLO MARKING CONES

Heavy Duty, 40 cms PE.

- 8 **57721** Colors: Red, Green, White and Yellow.



6



7



8

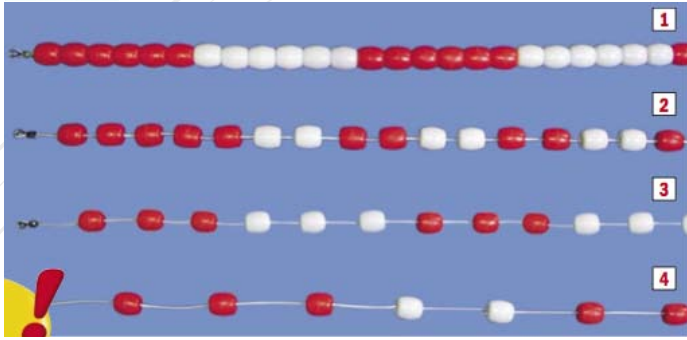

1—4



5



6

7



8



9

## SWIMMING LANE "INTERNATIONAL"

6 mm Polypropylene rope with stainless steel snap – hooks and galvanized eight link adjustment Thick – walled tubular Hostalen floats without spacers. 13 balls (70x65mm) per metre. Ends 5 m red, rest 100 cm white and 100 cm. red. Any color combination in red, white, yellow & green is possible.

- 1 **57771** Complete lane 25 m
- 1 **57772** Complete lane 50 m

## SWIMMING LANE "CLUB"

6 mm Polypropylene rope with S/S snap – hooks and galvanized eight link adjustment. tubular balls Hostalen floats with spacers made of transparent PVC with 8 ball (70 x65mm) and 8 spacers metre. End 5m. red, rest 100 cm white and 100 cm red.

- 2 **57775** Complete lane 25 m
- 2 **57777** Complete lane 50 m

## SWIMMING LANE "SPECIAL"

6 mm polypropylene rope with S/S snap – hooks and galvanized eight link adjustment. tubular hostalen floats balls with PVC contains 6 balls (70x65mm) and 6 spacers per metre Ends 5 m red, rest 100 cm white and 100 cm red.

- 3 **57779** Complete lane 25 m
- 3 **57780** Complete lane 50 m

## SWIMMING "TRAINING"

6 mm polypropylene rope with S/S snap – hooks and galvanized eight link adjustment. tubular hostalen floats balls with PVC spacers contains 4 balls (70x65mm) and 4 spacers per metre Ends 5 m red, rest 100 cm white and 100 cm red.

- 4 **57782** Complete lane 25 m
- 4 **57783** Complete lane 50 m

## RACING LANE ACCESSORIES

- 5 **57681** Float , 100mm in four colours
- 5 **57683** Float, Round in four colours.
- 7 **57682** Hostal Floats
- 8 **57684** Hostalen Tubular Floats in White, Yellow, Green & Red
- 9 **57685** Professional float.





2

### GYMNASTIC ROPES - F.I.G.

F.I.G. Approved - Official  
10mm Braided Polypropylene Rope in 10 attractive colors

- 1 **42102** 280 cms - 105 gms.
- 1 **42103** 300 cms - 120 gms.
- 2 **42104** 330 cms - 125 gms

New Packaging for a pack of 10.



1



3

### GYMNASTIC ROPES - DUAL

Available in attractive color combinations.

- 3 **42112** 280 cms - 105 gms
- 3 **42113** 300 cms - 120 gms
- 3 **42114** 330 cms - 125gms.



### GYMNASTIC CLUB

- 4 **42351** Competition Plastic Clubs, 44 cms. 160gms.

### MOULDED FLAT HOOPS

Durable Plastic moulded hoops without seams.  
A fun way of getting in shape.

- 5 **42215** 70cms
- 5 **42216** 60cms
- 5 **42217** 50cms
- 5 **42218** 40cms



4

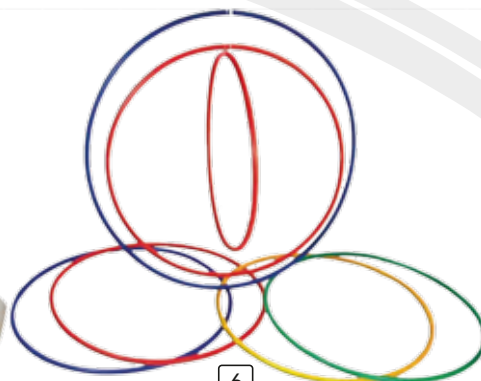

6

### GYMNASTIC HOOPS - ROUND

Heavy Duty round tubular hoops with concealed WELDED joints. Designed to teach grace and rhythm in dance and gymnastic classes. Also fun for recreational play or for use as markers and targets

- 6 **42331** 36" (915mm)
- 6 **42332** 30" (760mm)
- 6 **42334** 24" (610mm)

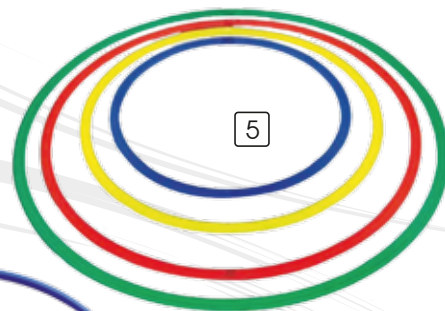

5

### GYMNASTIC HOOPS - LIGHT WEIGHT

19mm tubular hoops with plastic joints.  
Easy to hold profile.

- 7 **42341** 36" (915mm)
- 7 **42342** 30" (760mm)
- 7 **42343** 24" (610mm)
- 7 **42344** 18" (460mm)

19mm tubular hoops with welded joints.

- 7 **42341** W 36"
- 7 **42342** W 30"
- 7 **42343** W 24"
- 7 **42344** W 18"

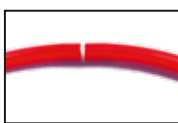

PLASTIC JOINT

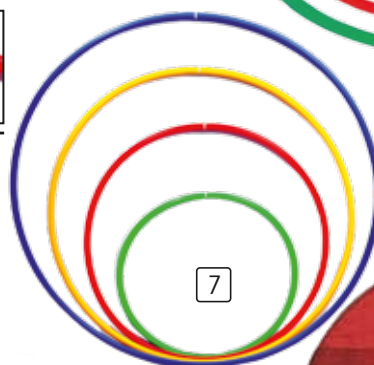

7



WELDED JOINT

### HOOP BAGS

Hoop bags are perfect for storing, transporting or hanging your hoops. Made of durable nylon, heavy-duty zipper & carry straps. Great way to keep all your hoops clean and looking like new. Hold 10 hoops.

- 8 **42391** For 50/60 cms Moulded Flat Hoops (65 x 65 x 25 cms)
- 9 **42393** For 70/80 cms Moulded Flat Hoops (85 x 85 x 25 cms)



8



2

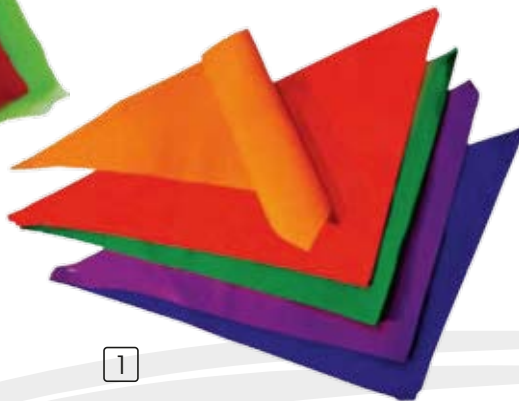

1



6

### RHYTHMIC SCARVES

For Dramatic movement & recreational use.  
Available in 6 Rainbow colours.

- 1 **42376** Cotton fabric - 50 x 50 cms.
- 2 **42378** Light Nylon - 140 x 140 cms.

### MOMENTUM ROPES

10mm Braided Polypropylene Ropes.

- 3 **42381** Pink - 8 Meters.
- 4 **42383** Green - 10 Meters.
- 5 **42384** Blue - 15 Meters.



3

4

5

### 50M ROLLS

50 M rolls which give you the flexibility to cut rope length of any size up to 50m.

- 6 **42388** Available in 4 Team colours.

### GYMNASTIC ROPES - TRAINING

8mm Braided Rope in attractive colors.

- 7 **42123** 300 cms - 95 gms.
  - 7 **42124** 300 cms - 85 gms.
- Specific length of ropes are also available on request.



7

### GYMNASTIC CORDS

8mm synthetic elastic cord for Multi training with plastic carabines at both ends.

- 8 **42363** 8 Meters
- 8 **42365** 10 Meters
- 8 **42366** 12 Meters
- 9 **42369** 12 Meters Knotted ends in packaging.
- 10 **42371** 6 Meters.
- 11 **42372** 10 Meters.



8

9

### GYMNASTIC BARS

25mm Strong Heavy Duty Pvc Bars with screwed caps at ends.

- 12 **42381** 80 cms.
- 12 **42382** 100 cms.



12



10

11



1

### MUSHROOM HORSE

60 cms Height, 60 x 60 cm top  
Base pipe: 100 x 50 x 3mm. Support pipe 80 square

1 **42391** Black

### WALL BAR

Made of superior Marandi wood.

2 **42394** Height : 2.50M Width: 1M

### GYMNASTIC BENCH

Superior wood durable.

3 **42395** 2.5M

3 **42396** 3M

3 **42397** 3.5M

### VAULTING BOX

Made of superior Marandi wood upholstered with synthetic leather.

4 **42398** Senior.

4 **42399** Junior.



2



3



4

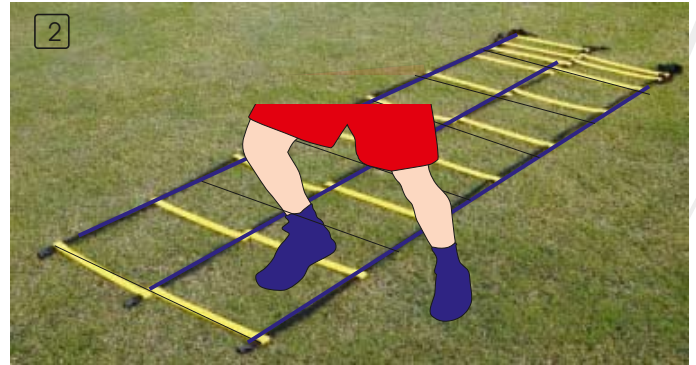
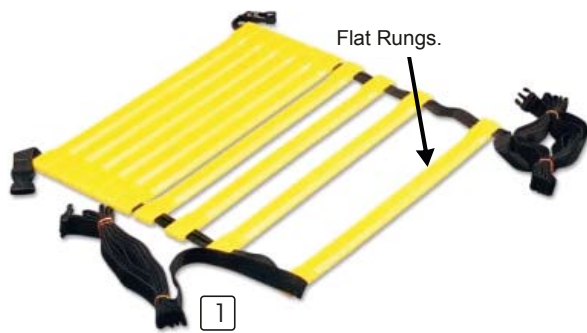

### FOOTSPEED LADDER - FLAT OUTDOOR

A popular training aid for improving footwork skills, agility, coordination and balance. Different drills can be practised by changing the distance between the rungs (closer together for short, quick stepping drills or adjust further away for longer stride drills). The clips at the end allow ladders to be joined easily to create a long run. Includes carry bag.

- 1 **54401** 2M 5 RUNGS
- 1 **54402** 4M 10 RUNGS
- 1 **54403** 9M 21 RUNGS



### FOOTSPEED LADDER - DOUBLE FLAT

With Double foot pattern, The distance between the two successive rungs can be adjusted to suit your requirement. Proves to be a very effective training aid. Includes carry bag.

- 2 **54408** 4M 10 x 2 RUNGS
- 2 **54409** 9M 21 x 2 RUNGS

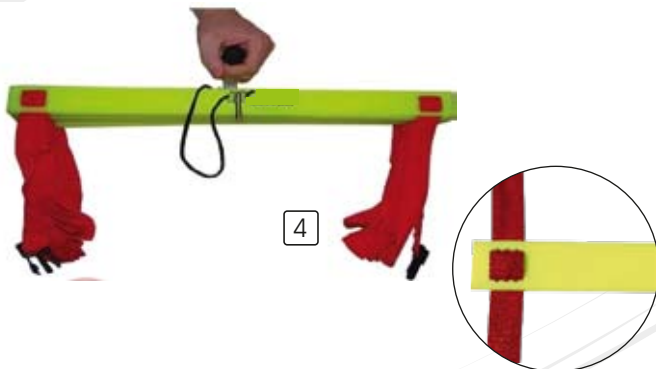

### FOOT SPEED LADDER – INDOOR / OUTDOOR PREMIUM MODEL

Same as above, It can be used both indoors and outdoors surface. Provided with ground pegs for usage OUTDOORS. The vacuum mechanism holds the ladder for usage INDOORS.

- 3 **54405** 4M 10RUNGS
- 3 **54406** 9M 21RUNGS

### FOOT SPEED LADDER - FLAT OUTDOOR Premium

Providing with a stacking pin that avoids tangling and facilities easy & quick storage of the ladder. Both rungs and webbing can be customized with logo. Includes storage handle and carry bag.

- 4 **54412** 4M
- 4 **54413** 9M

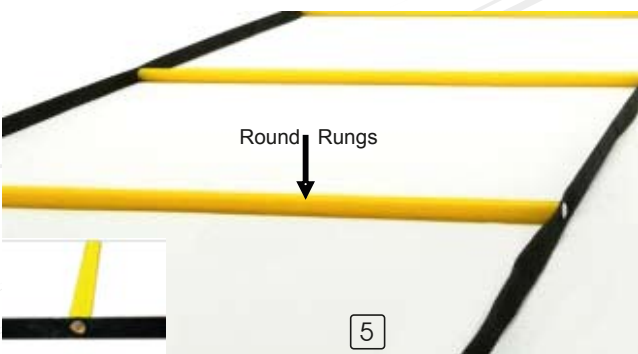

### FOOT SPEED LADDER - ROUND PREMIUM MODEL

Heavy duty speed Ladder is the most simplistic and versatile training tool. Teaches basic skills to beginners, as well as allowing highly advanced athletes to develop blistering foot speed. Rungs are spaced 40cms apart, connected with durable webbing. Connectable to make any length with another ladder using buckles. Includes Carry Bag.

- 5 **54221** 2M 5 RUNGS
- 5 **54222** 4M 10 RUNGS
- 5 **54223** 8.5m 21 RUNGS

### FOOTSPEED LADDER - ROUND DOUBLE

The double pattern adds more versatility to the drills being practised with the ladder. Consists of 10 x 100cm long rungs with center webbing.

Each Block size 50 cm x 45cms.

- 6 **54224** 4m 10 rungs
- 6 **54225** 9 m 21 rungs.

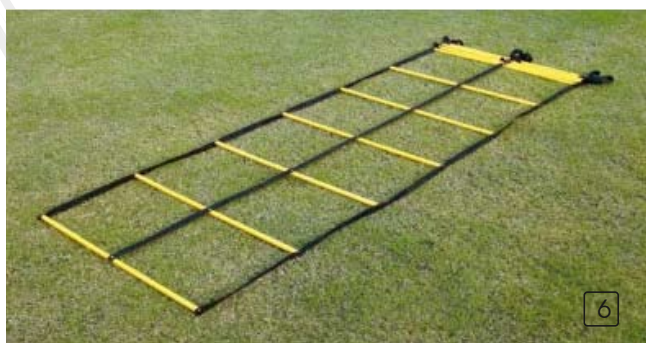



1

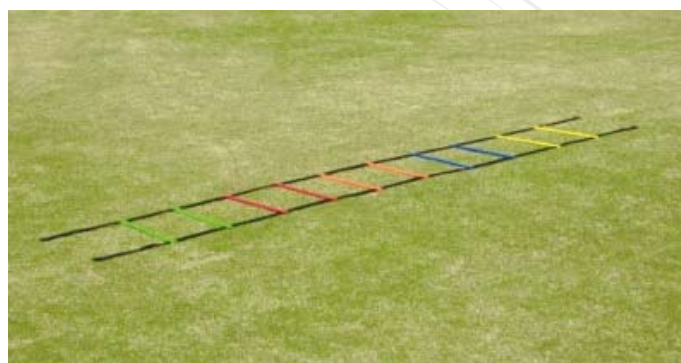

2



3

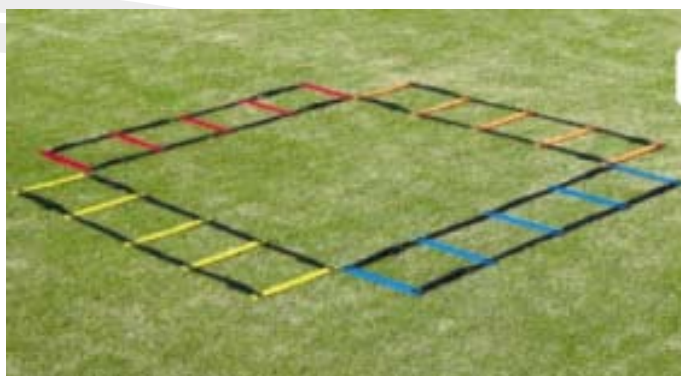

4

### FOOT SPEED LADDER - SCHOOL FLAT

Speed training ladder with School, flat adjustable rungs (40cms wide) available in different sizes. Economical in cost.

- 1 **54410** 4m 10 RUNGS
- 1 **54411** 9m 20 RUNGS

### FOOT SPEED LADDER - SCHOOL MULTI

Speed training ladder School, Flat adjustable rungs (40cms wide) in different sizes. Economical in cost..

- 2 **54419** 4m 2 rungs each of Red / Yellow / Blue / Orange & Green
- 2 **54420** 9m 4 rungs each of Red / Yellow / Blue / Orange & Green

### FOOT SPEED LADDER - RINGS

Made of Hoops with alternatively Red/Yellow/Green & Blue attached together. Rings can be adjusted to change direction, angle. Easy to fold with mesh carry bag.

- 3 **54421** Set of 12 rings

### FOOTSPEED LADDER - QUAD

Set consists of 4 ladders flat. The connector is used for joining all the four ladders. Different arrangements with the ladders enable a variety of drills to be performed. Red / Blue / Yellow & Orange.

- 4 **54416** 2M 5 RUNGS- Set of 4 in ONE OF EACH COLOUR
- 4 **54417** 4M 10 RUNGS- Set of 4 in ONE OF EACH COLOUR
- 4 **54418** 9M 21 RUNGS- Set of 4 in ONE OF EACH COLOUR

### FOOT SPEED LADDER - QUAD ROUND

Consists of 4 detachable ladders which can be used separately for footwork drills. 40cm wide round rungs, spaced 50cms apart.

- 5 **54422** 2 Meters (5 rungs) x 4 ladders in 4 Team colors

### SPEED TRAINING LADDER RAINBOW

Set of six detachable Rainbow ladder - one of each of the six colors an ideal for basic movement, agility, balance, running, co-ordination, jumping and various training activities. spaced 30cms apart.

- 6 **54427** 2 Meters x of 6 ladders (Red, Yellow, Blue, Green, Orange & Purple).



5



6

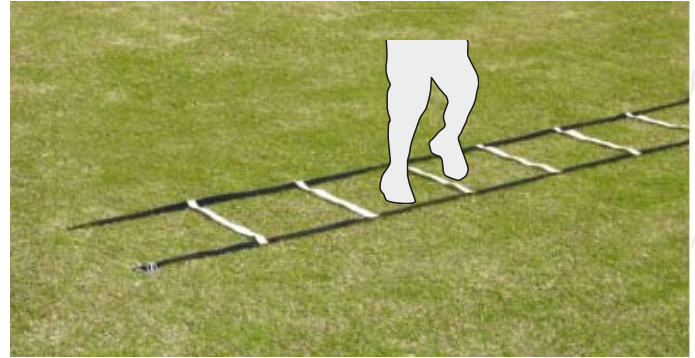
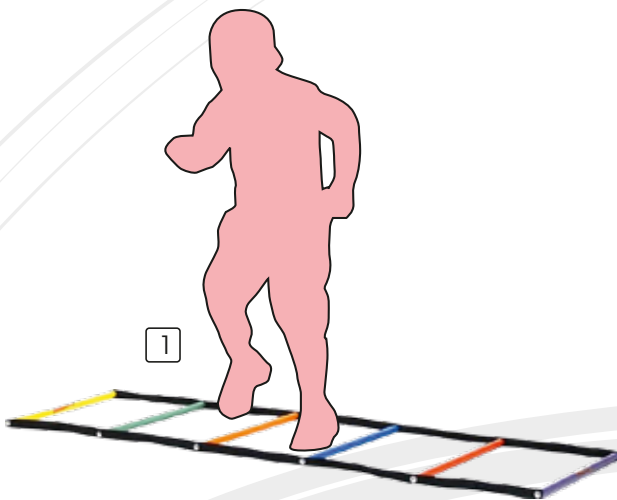

### TRAINING LADDER RAINBOW-ROUND

Made up of 1 x Red, Green, purple, orange, yellow and blue rungs. Used as a multi colored gives coaches for great activity. By changing the activity or position of each color you recall, color perception to have more fun.

- 1 **54428** 2 Meters - 6 rungs.

### FOOTSPEED LADDER FLAT ECONOMY

The plastic rungs are replaced by 1" wide webbing which makes the ladder light weight and economical with 4 ground spikes to hold the ladder.

Includes ground pegs and carry bag.

- 2 **54429** 10 Rungs 4 Meters
- 2 **54430** 18 Rungs 8.50 Meters

### FOOTSPEED LADDER - FLAT FIXED

Nylon bound 40cm wide rungs with FLAT Bottom, spaced 40cms apart. Printed webbing. Includes carry bag.

- 3 **54226** 5 Rungs 2 Meters
- 3 **54227** 10 Rungs 4 Meters
- 3 **54228** 18 Rungs 8.5 Meters

### TRAINING LADDER RAINBOW - FLAT

Nylon bound wide run as in 6 rainbow colours.

- 4 **54231** 6 Rungs 2 Meter.

### SPEED TRAINING LADDER - SCISSOR

Flexible CROSS Sticks is perfect for TRAINING activities to perform different kinds of drills by adjusting the sticks in different directions from simpler to more complicated drills.

- 5 **54230** 4 Meters - 10 Cross strips.

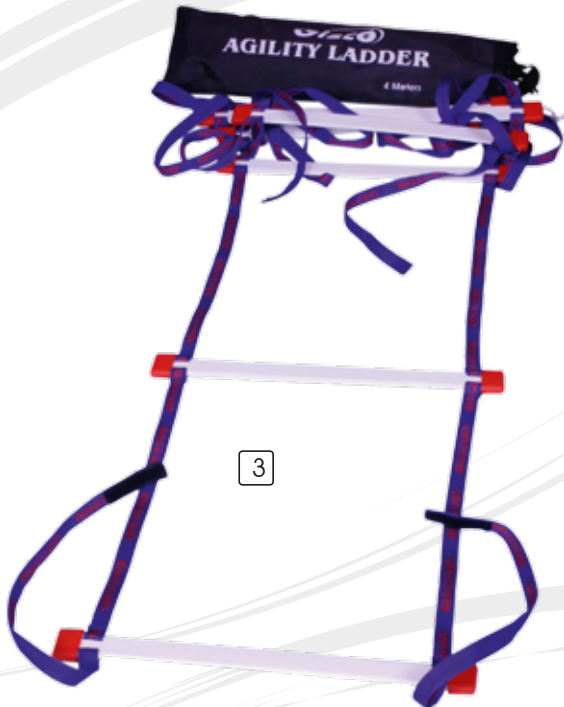

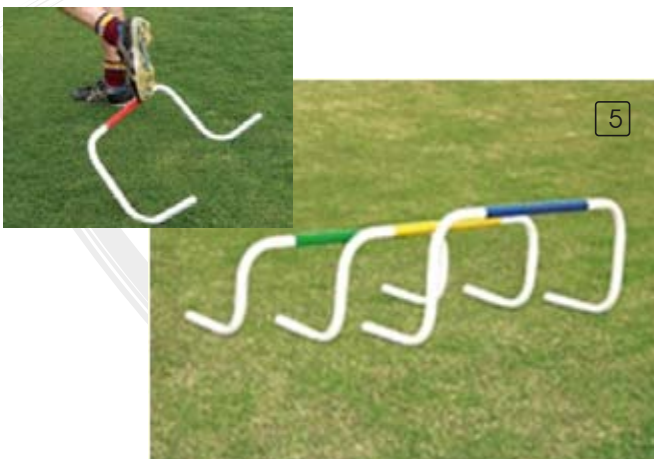

### AGILITY HURDLE – MICRO

A very effective training aid for quick knee lift and stepping and help to increase the players' speed, balance, agility, coordination, footwork and turning ability.

- 1 **54210** 4"-10 cm
  - 1 **54211** 6"-15 cm
  - 1 **54212** 9"-22.5cm
  - 1 **54213** 12"-30cm
  - 1 **54214** 15"-38cm
  - 1 **54215** 18"-45cm
- 54211P** Pack of 6 in Carry Bag (6")
  - 54212P** Pack of 6 in Carry Bag (9")
  - 54213P** Pack of 6 in Carry Bag (12")

### HURDLE CARRIER

- 2 **54215** Holds 12 Step hurdles of any size (15, 30 or 50 cm). Easy to use Velcro that wraps around the top of the hurdle to make transportation and storage easy and convenient.
- 3 **54216** Polyester coated bag Carries Up To 12 Hurdles micro hurdles depending on size.

### AGILITY HURDLE-2 in 1

Adjustable to two different heights. Height is adjusted by easy snap locking mechanism and twisting the hurdle's foot.

- 4 **54219** Height 6" and 12"
- 4 **54220** Height 12" and 20"

### AGILITY HURDLE – Bounce Back

Durable plastic construction. These hurdles return back to original position after being knocked over. This eliminates the time loss involved in setting up the fallen ladders after the drill.

- 5 **54260** 20cms
- 5 **54261** 30cms
- 5 **54262** 40 cms
- 5 **54263** 45cms
- 5 **54264** set of 4 each of 20,30,40 and 45cms

### TRAINING Hurdle - Bounce Back

With a unique feature-it returns back to its position when knocked down. A perfect training hurdle for quick knee lift and stepping. This eliminates time-breaks while doing drills. Available in different heights.

- 6 **54291** 40cm High-width 60cm.
- 6 **54292** 50cm. High-width 60cm.
- 6 **54293** 60cm. High-width 60cm.

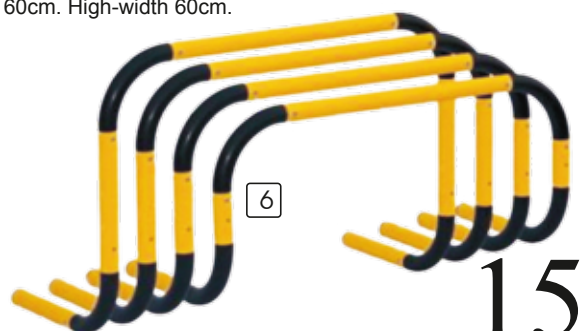

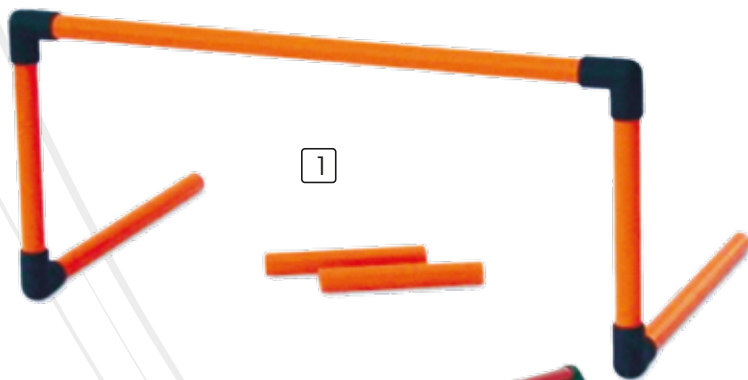

1



2

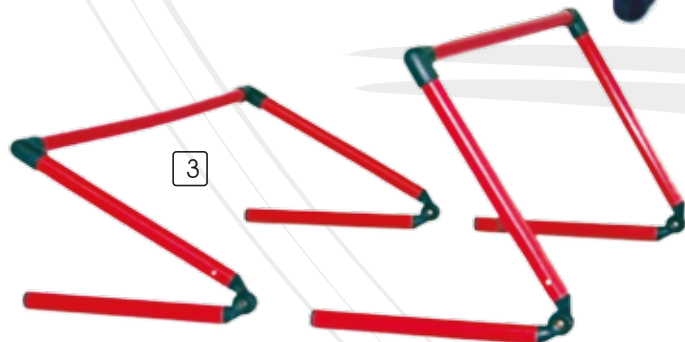

3



4

### AGILITY HURDLE-PORTABLE 3 in 1

Hurdle set consists of 7 posts to give the user three different heights 6", 9", 12".

- 1 **54279** Pole Dia 25mm

### AGILITY HURDLE-HEIGHT EXTENDER

Unique tools to extend the Height with any of Gisco Agility hurdle (20mm).

- 2 **54284** 3 inches Height Extender with clip.
- 2 **54285** 6 inches Height Extender with clip.
- 2 **54286** 9 inches Height Extender with clip.

### AGILITY HURDLE-Adjustable

Hurdle can be adjusted from 3" to 15" at different Heights

- 3 **54281** Individual piece
- 3 **54282** Set of 6 with carry bag

### MULTI TRAINER HURDLE

One leg training hurdle with different height adjustment.

- 4 **54308** 22cm to 31cm.
- 5 **54309** 12cm to 20cm.



5

### AGILITY HURDLE-PORTABLE

A perfect Folding hurdle is made of 25mm tube for quick knee lift, stepping and polymetric jump.

- 6 **54271** Height 6" 20 cms
- 6 **54272** Height 9" 23 cms
- 6 **54273** Height 12" 30 cms
- 6 **54274** Height 15" 40 cms
- 6 **54275** Height 18" 50 cms

### AGILITY HURDLE-DUAL

Dual Height economical Training Hurdle.

- 7 **54287** Combination of 15 cm (6") & 30 cm (12").
- 7 **54288** Combination of 23 cm (9") & 30 cm (12").

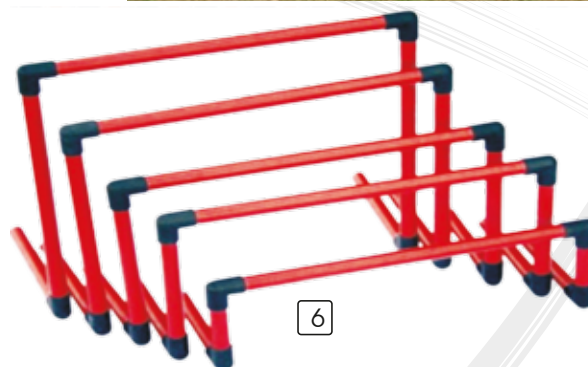

6



7



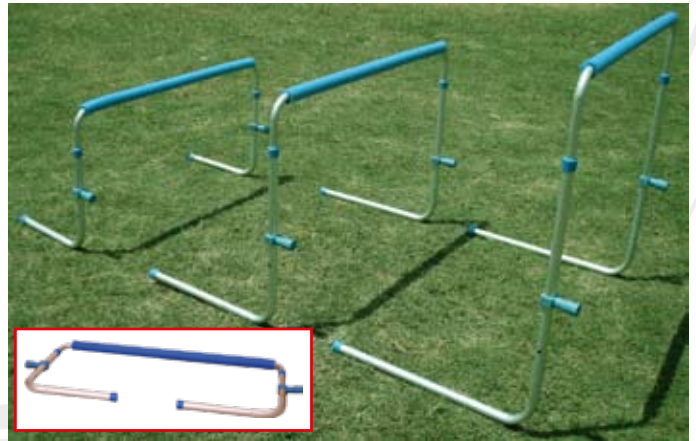
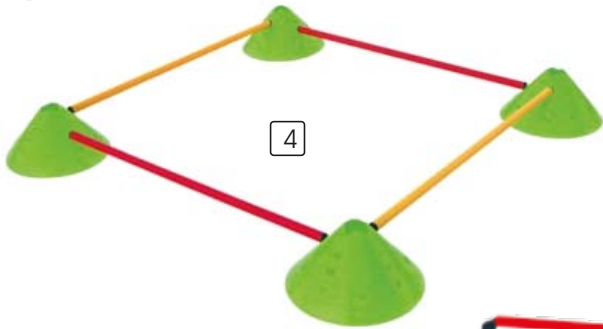
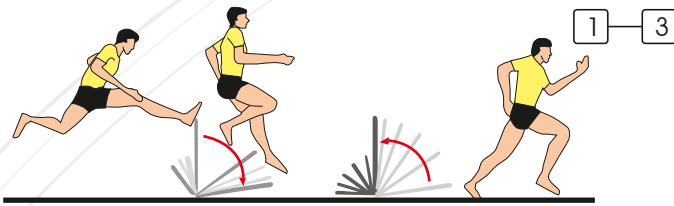

### RETURN TRAINING HURDLE

This new hurdle will stand up again when knocked down saving time going around putting hurdles up again. It is a perfect training instrument with many variations. Stable, light aluminium construction with folding in feet.

Height adjustable from 66-106 cm. Seven heights: 66, 71, 76, 84, 81, 100 and 106 cm, width 88 cm. 2.6 kg.

1 **59511 MAXI**

Height adjustable from 55-84 cm. Seven heights: 55-70 cm in 5cm stages, 76, 80, 84 cm, width 83 cm. 2.2 kg.

2 **59512 MIDI**

Height adjustable from 40-60 cm in 5 cm stages, width 81 cm. 1.6 kg.

3 **59513 MINI**

### MULTI HEIGHT TRAINING SET

Pole can fix on the cone at different position to have four height levels.

4 **59604** Set of 4 Cones & 4 poles

4 **59407** Set of 8 Cones & 8 poles

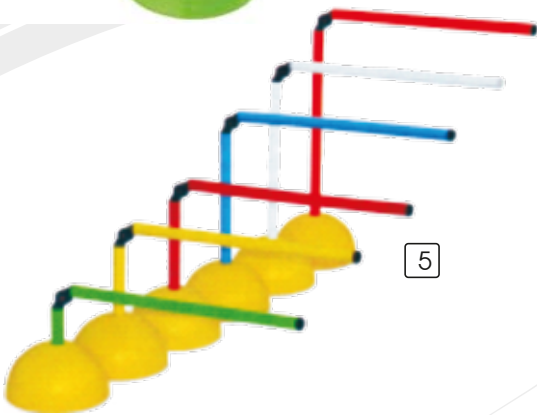

### HURDLE POLES

25 mm Plastic Pole with Dome bases & adjustable jointer so that can be folded for transportation.

5 **59411** 9" 59411PK 9" - Set of 6

5 **59412** 12" 59412 PK 12" - Set of 6

5 **59413** 15" 59413 PK 15" - Set of 6

5 **59414** 18" 59414 PK 18" - Set of 6

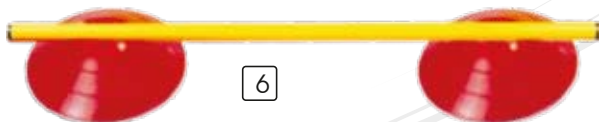

6



7

### CONE AGILITY HURDLE 3"

Set consist 2" cut marker with in plastic poles.

6 **59401** Set of 12 marker 2" & 6 poles.

6 **59402** Set of 20 marker 2" & 10 poles.

### CONE AGILITY HURDLE

Consists 6" cut marker with 1 M plastic poles.

7 **59405** Set of 12 marker 6" & 6 poles.

### JUMP TRAINING HURDLE

Circuit Training, 2 cones, 2 support with height marking and 1 PVC pipe of 100cm.

8 **54114**

### AGILITY TRAINING SET

12 CONES 40cm with hole and 6 Poles 1 Meters for multi agility training.

9 **54337** Available in Red, Blue and Yellow

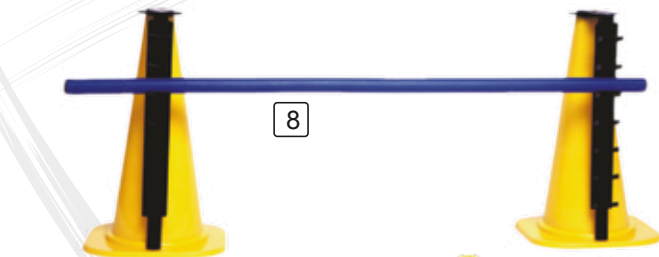

8



9

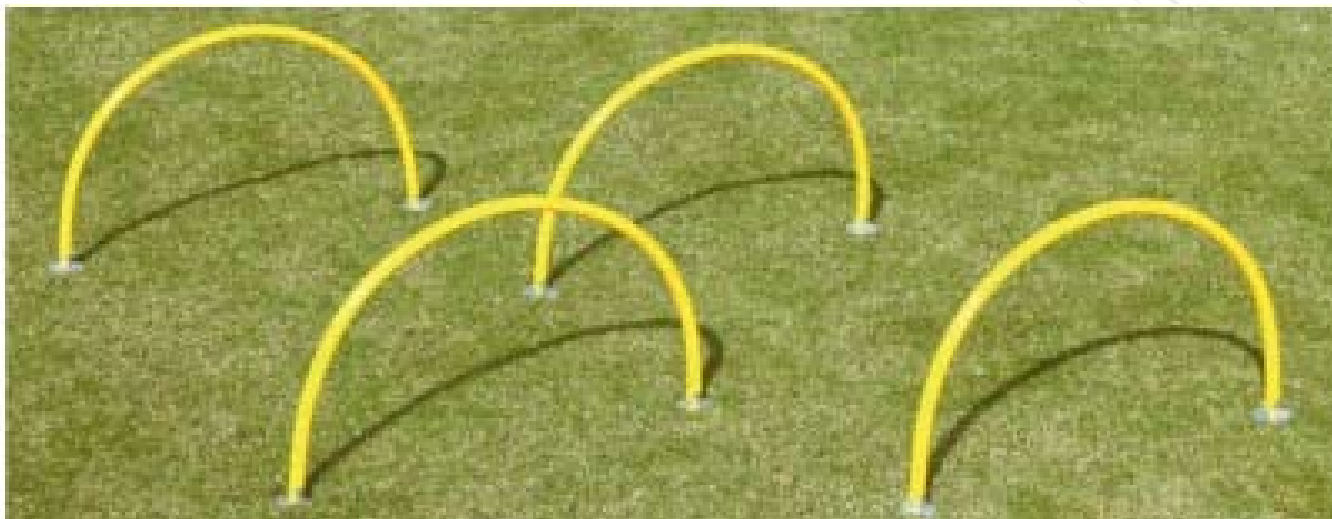

1



2



3



### TRAINING ARC-Round

20mm Heavy duty arcs. An Ideal training tool for improving passing skills and shooting. Fitted with galvanized 8mm steel spikes at both ends.

Height 13", Width 18".

- 1 **54321** Individual
- 1 **54322** Set of 5

### TRAINING ARC-Square

20mm Training arcs with steel spikes, which can be screwed to the arc while using and can be taken out when not in use. Height 18", Width 18"

- 2 **54324** Individual

### TRAINING ARC-Portable

25mm Arc which can be folded thus lending ease to its transportation and storage. The 8mm spikes at the ends of the arc provide for easy insertion into the ground. An elastic cord is interconnected so after folding all the part will stay together.

Height 18", Width 18"

- 3 **54327** Individual
- 3 **54328** Set of 5



4

### TRAINING ARC- Spring Loaded

25mm Heavy duty arcs with spring loaded.

- 4 **54330** Individual

### TRAINING ARC- Heavy Duty

20mm Heavy duty arcs an Ideal training tool for improving passing skills and shooting. Height: 13" and Width: 20"

- 5 **54320** Individual

5





2



1

### SLALOM POLE BASE

1 **54300** Heavy duty plastic base, 1.25" (30mm) dia.

### SLALOM POLE ELEMENTARY

Power Coated metal spikes at the bottom

2 **54301** - 30mm dia x 1.72M length PVC poles.

### SLALOM POLE FOLDING

Power coated metal spikes at the bottom.

3 **54302** · Two 1.28" dia X 30" length PVC poles with connector for easy transport & storage.

### SLALOM POLE SPRING BASE

Power coated spring base with metal spikes at the bottom.

4 **54303** · 1.25" dia x 68" length PVC poles.

### SLALOM POLE CENTER SPRING

Power coated metal spikes at the bottom.

5 **54304** · Two 1.25" dia x 30" length PVC poles connected with spring at the middle.

### SLALOM POLE - RUBBER ENCASED

bottom 25mm Yellow pole 183cm, rubber encased flexible spike at base.

6 **54305** Fixed model - one piece

7 **54306** Folding fixed with elastic cord inside - for easy transportation

### SLALOM POLE CARRY BAG

Made of tough synthetic fabric.

8 **54311** · Built to accommodate 12 poles.

### AGILITY TAPE

Consists of 12 weighted bags on 50" long synthetic tape.

9 **54312** · Bags on both ends are fixed. Other 10 bags can be adjusted anywhere along a carry bag.

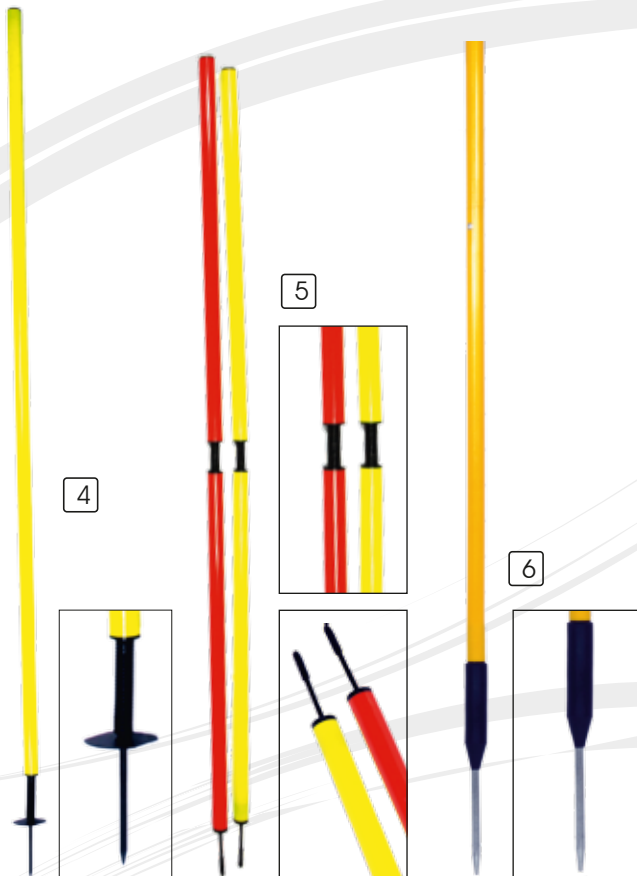

3

4

5

6

7



8

9



### MULTI SEQUENCE MARKERS

Non slip Rubber markers for Outdoor & Indoor use for teaching, animate training and co-ordination skills.

1 54201-54209

### SEQUENCE MARKERS-CIRCLE

2 54211 Circle 23 X 23cms. Set of 4

### AGILITY DOTS

6" Non-slip, Bright, colorful, multi-purpose spots for high visibility, quick-foot reaction and change of direction drills. Ideal for gymnasiums, playgrounds and for organizing activity units

3 54199D Six dots per set.

### AGILITY SPOTS

Flat Rubber Square Markers 30 X 30 cms.

4 54199S Set of 6.



Gymnastic

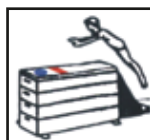

Box Jumping



Starting Marker

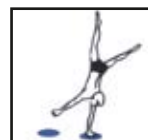

Physical exercise

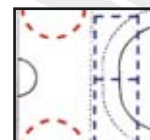

Field Marking

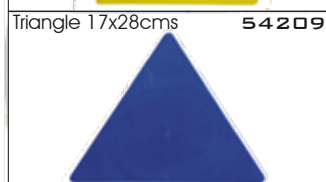
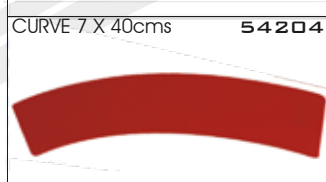
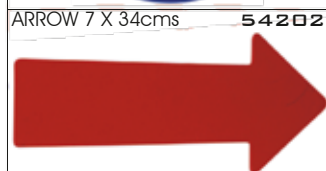
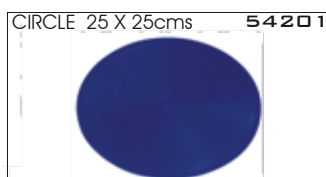

2



3



4



### REACTION BALL (Z-BALL)

Perfect for improving eye-hand coordination and reaction time in any sport. The random bounces of the reaction ball improve overall coordination, reaction time and depth perception. Ball can be bounced off any hard surface.

- 1 **54331** 70mm - Single color
- 2 **54332** 70mm - Blue and yellow on gym floors
- 3 **54333** 70mm - Orange and yellow on darker surfaces
- 4 **54334** 100mm - larger size bounces higher and easier to catch.

### REACTION HOOPS

- 5 **54250** 60cm Dia hoops, fitted with three sponge Balls. The ultimate footwork training.

2 — 3

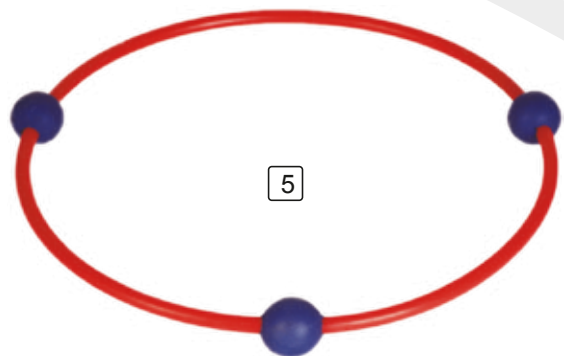
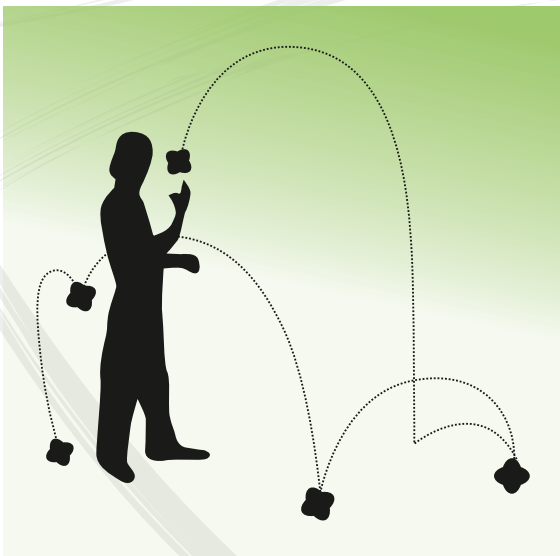



## POWER SPEED RESISTOR

This equipment helps to improve your sprinting by using resistance. Your partner is holding you back, making it difficult for you to sprint.

- 1 **54351**

1



## SPEED CHUTE

A popular speed training equipment, can be used without a partner. Improve acceleration, speed, endurance & high-speed direction change. The Parachute provides both resistance and over – speed training. Adjustable waist belt fits a 20" to 42" waist and allows for training in any direction.

- 2 **54354** 40"
- 2 **54355** 48"
- 2 **54356** 56"
- 2 **54357** 72"

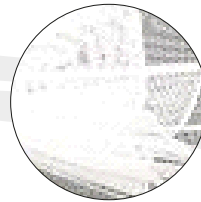

2

Mesh Panels eliminate tangling and add stability

## EVASION BELT (BREAK AWAY)

Have fun while you improve speed, agility, balance and reaction time. Partner up and see who can move the quickest and be first to break away. Easy to adjust waist belts connect with velcro strap.

- 3 **54255** Set of 2.

## WEIGHTED POWER SLEDGE

Another ideal option for Speed Training. Heavy Duty Tubular steel, power coated for durable finish. Belt fits upto 48" waists.

- 4 **54360** Foldable for easy transport.

## RESISTANCE TRAINER

This resistance training device is the most economical. Requires two players for training; one provides resistance while other one runs. Includes 3m long web with grip handles and one waist belt (adjustable up to 42" with the help of Velcro) or shoulder harness. Comes in a mesh bag.

- 5 **54371** Shoulder Harness
- 5 **54372** Waist belt



3



## DUAL RESISTANCE TRAINER

This resistance training device requires two athletes for training; one provides resistance while other one runs. Includes 10' (3m) long web, 2 x waist belts (adjustable up to 42" with the help of Velcro) or shoulder harness. Comes in a carry bag.

- 6 **54373** Shoulder Harness
- 6 **54374** Waist belt

## MULTI – RESISTANCE TRAINER

Multi – Resistance trainer made of latex tubes combined with sturdy clamps can be used for variety of resistance training. Clamp & Handles are pre-attached with the cord, includes waist belt (adjustable up to 42" with the help of Velcro). Comes in a mesh bag. It is available in following options:

- 7 **54376**–10F Includes 10' (3m) Latex Tube + Waist belt
- 7 **54377**–20F Includes 20' (6m) Latex Tube + Waist belt
- 7 **54378**–5F2 Includes 5' (1.5m) X 2 Latex Tube + Waist belt



4

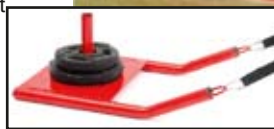

## FITNESS RING

The resistance latex tube with PU soft handle. One is with light resistance and the other with heavier resistance.

- 8 **54380** Set of 2.

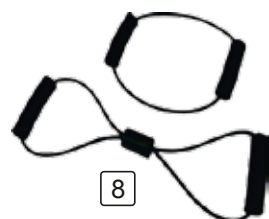

8



7



5

6



2

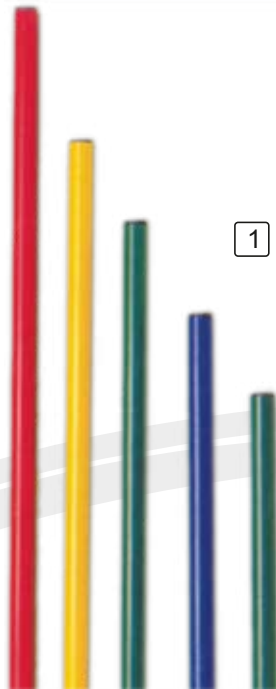

1



4

### MULTI TRAINER POSTS

Make the training more eventful. For Ball training, for athletic events and improving the coordination skill as training goals.

POSTS Ø 25MM

- 1 **54101** Length 180 cm
- 1 **54102** Length 160 cm
- 1 **54103** Length 120 cm
- 1 **54104** Length 100 cm
- 1 **54105** Length 70 cm
- 1 **54107** Length 35 cm

### CLIPS FOR POSTS

Clips 360°

- 2 **54110**

### POLE BASES - RUBBER

Multi Purpose, easy to use, good gripping to any surface. No need to use sand filling.

- 3 **54111** Base - 700 g. Black for 25 mm. OD Pole.
  - 3 **54112** Base - 700 g. Colored for 25 mm. OD Pole.
  - 4 **54113** Base - 1200 g. Black for 25 mm. OD Pole.
  - 5 **54114** Base - 1500 g. Black for 30-32 mm. OD Pole.
  - 6 **54116** Base - 3kg. Black
- Suitable for Poles upto 27 mm. dia and Synthetic poles with a dia of 50 mm. are placed over the socket

### POLE BASES - PLASTIC

Multi Purpose to be used on any surface.

- 7 **54146** Base Plastic can filled with sand. for 25 mm. OD Pole.
- 8 **54147** Multi Purpose Base. Confilled with sand. Suitable for 25 mm. Pole, Flat Hoops & Round hoops.
- 9 **54148** Base solid Plastic suitable for 30/32 OD Pole.



3

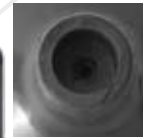

TOP VIEW

5



6



7



8



9





1

### MULTI JUMP TRAINER

Suitable for various activities : side jumps, stepping , jogging etc.  
The posts can be adjusted at different heights and also in different directions to suit individual needs.

- 1 **59371** Set with 50 cm poles (Containing two poles, 2 connectors, one Dome base)
- 1 **59372** Set with 80 cm poles (Containing two poles, 2 connectors, one Dome base).
- 1 **54219** Height 6" and 12"
- 1 **54220** Height 12"and 20"

### MULTI TRAINER KIT

Can be used on turf surfaces, indoor or outdoor with carry bag.

- 2 **59384** 8 bases, 12 yellow poles 170 cm long, 8 clips
- 2 **59385** 8 bases, 12 yellow poles 140 cm long, 8 clips

### MULTI TRAINER KIT-Rubber

Can be used on turf surfaces, indoor or outdoor with carry bag.

- 3 **59387** 8 Rubber bases, 6 Yellow & 6 Blue poles 170 cm long and 8 clips

### MULTI ACTIVITY SET

- 4 **59390** An ideal product for Primary play and training.

Set consists of:  
6 Dome bases  
6 Yellow+3 Red Poles 100 cm.  
2 Flat hoops 60cms  
4 Blue + 6 black Connecters

### DRIBBLING POSTS- Dome base

Durable PVC posts with Dome base helps in elimination of bad posture and improving change of direction. Bases can be filled with sand/gravel for stability

- 5 **59374** Individual-Base & post (100cm)
- 5 **59374S** Set of 6

### DRIBBLING POSTS-Rubber

Rubber, resistant base with 25mm PVC post. Ideal training technique by marking strict passing routes

- 6 **59380** Base & post (100cms)
- 6 **59380S** Set of 6



2



3

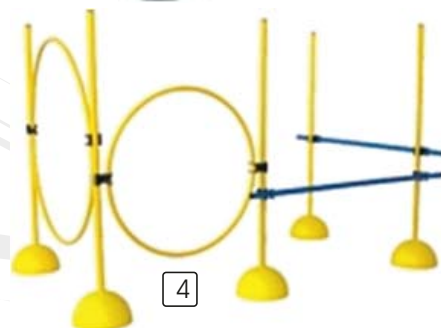

4

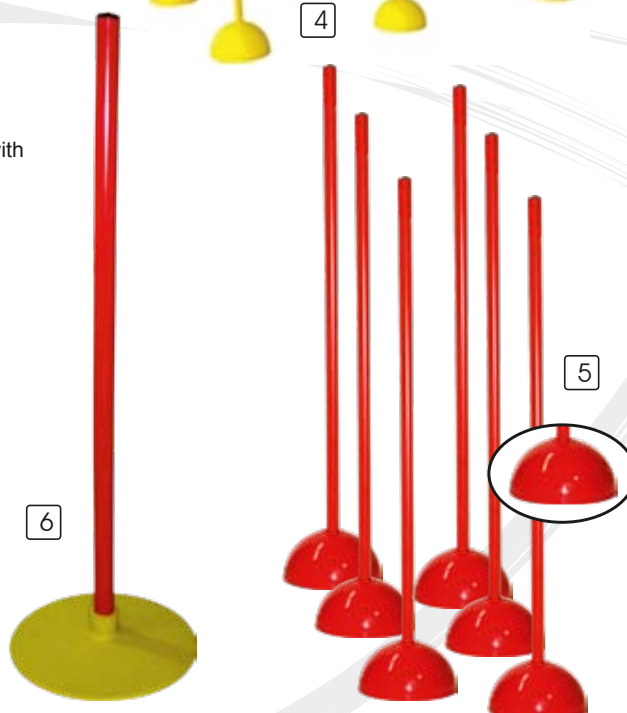

6

5





### SPACE MARKERS

"Half-cones" or spots can be used for many activities and games Drills, sideline/boundary markers, obstacles, targets in Red, Yellow, Blue, Green & White with Carry device.

- 1 **54151** Set of 50 (10 of each)
- 1 **54152** set of 40 (8 of each)
- 1 **54153** Individual - 30g
- 1 **54154** Individual - 26g
- 1 **54155** Carry device Metal to hold 100.
- 1 **54156** Carry device Plastic to hold 50.

### SPEED MARKERS

- 2 **54171** 3"- 7.5 cm Small Set of 24( Yellow-12, Red-12)
- 3 **54172** 6"- 15 cm Large Set of 24( Yellow-12, Red-12)
- 4 **54173** 6"- 15 cm Large - new design set of 12 (Yellow-6, Red-6)

### SPEED RINGS

Improve quickness, balance, coordination and reaction time with these lightweight flexible rings Patterns can be quickly and easily changed to target specific needs Made of soft, durable Plastic to provide traction during use 18" Diameter Flat rings

- 5 **54346** Set of 12 multicolored in a bag

### MULTI DOME CONES

Use them for cones, markers, boundaries, lane markings, obstacles, targets, etc. Domes measure 7 3/4" in diameter and are 3 1/4" high

- 6 **54164** Rigid - set of 40.
- 6 **54162** Soft - set of 40.

### AGILITY QUAD

Ideal for improving foot quickness and change of direction Incorporate jumps in all directions: Front to back. Side to side. Diagonal

- 7 **54341** Pvc pipe, foldable.
- 8 **54342** Synthetic stitched.

### NUMBERED DRILL CONES

These 9" tall unbreakable cones are great for a variety agility and coordination drills Cones are numbered 0 through 9. Use indoors or outdoors Place cones in various configurations and use the different colors to indicate direction changes.

- 9 **54347** Light 90g. Set of 10.
- 9 **54348** Heavy Duty 105g. Set of 10.





### POP UP CONE

1 **54158** 9" - 23 cms

### MARKER CONES-HEAVY DUTY

2 **54166** 9" 23 cm 90 gms  
 2 **54161** 9"-23 cm 105 gms  
 2 **54162** 12"-30 cm 170 gms  
 2 **54163** 15" 38 cm 270 gms  
 3 **54164** 15" 38 cm with hole  
 4 **54169** 18" 46 cm

### SLIT CONES

Light weight cone slit on three sides to prevent toppling by allowing the wind to pass through the slits. Square base for stability.

5 **54181** 12"  
 5 **54182** 15"  
 5 **54183** 18"



### FLEXIBLE CONE

Light weight cone does not break or crack when stepped.

6 **54184** 9"  
 6 **54185** 12"  
 6 **54186** 15"

### FLEXI CONE

Soft Pvc flexible cone.

7 **54190** 6"  
 7 **54191** 9"  
 7 **54192** 12"  
 7 **54193** 15"



### SPHERE CONE

Tough, Durable plastic cones are perfect for speed, quickness and agility drills.

8 **54194**

### WEIGHTED CONE

Red colour with weight base to keep the stability.

9 **54195** 6"  
 9 **54196** 9"  
 9 **54197** 12"  
 9 **54198** 15"

### MARKER CONE WITH HOLE

With convenient storage stand. Orange only. 9" - 90g.

10 **54170** Set of 20.  
 11 **54171** Stand Only





1



4

### PENALTY DUMMIES

Dummies for Penalty Training made of steel tube with 2 or 4 legs, Mesh frame or Heavy Duty Nylon Cover in middle & 4 steel pegs to insert into ground for holding the dummy. 180 cm high with 4 legs & mesh frame in middle.

- 1 **54951** 160 cm high with 4 legs & mesh frame in middle.
- 1 **54952** 180 cm high with 2 legs & heavy duty Nylon Fabric in middle.
- 1 **54953** 160 cm high with 2 legs & heavy duty Nylon Fabric in middle.



3

2



### PENALTY DUMMIES - Adjustable

- 2 **54954** These adjustable dummies can be used both indoors and outdoors. These dummies unlike common dummies available in the market dont have spikes which damage the ground. The bottom of the frame is designed in such a way that it can hold weights such as Water Tanks, Sand Bags, etc. For stability of the dummy. Feet are detachable, which saves space and transportation cost.

### SPRING RETURN PENALTY DUMMIES

- 3 **54955** Spring return penalty dummy is a perfect training dummy to practice more kicks in less time. The dummy itself comes back to its original position each time it falls down, which saves time of the player.

### PENALTY DUMMY WALL/CART -Super

- 4 **54958** Penalty dummy cart made of heavy duty steel suitable to carry 5x penalty Dummies. Wheel diameter 4" (10cm)

### SINGLE PENALTY DUMMY CART

- 5 **54961** Single penalty dummy cart made of heavy duty steel to carry single dummy only. Perfect for synthetic fields. Regular dummies with spikes can be fixed on this cart, so that players have the flexibility to use the dummy with or without cart. Comes with heavy duty wheels. Cart height : 15cm

### FREE KICKMAN

Light weight nylon, flexi under Pressure to absorb impacts.

- 6 **54966** 5 Ft. 11"



5



6

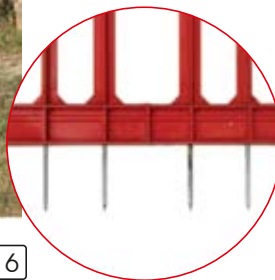



1

### PRO GOAL POST

- 1 **PG-12** 12' x 6'
- 1 **PG-08** 8' x 4'
- 1 **PG-05** 5' x 4'

70 mm pvc tubular construction.  
Superior design back supports use 40mm pvc tubes.  
Easy to install.  
Includes net, clips and ground anchors.  
Comes in a carry bag.



2

### CLUB GOAL POST

- 2 **PG-112** 12' x 6'
- 2 **PG-108** 8' x 4'
- 2 **PG-105** 5' x 4'

70 mm pvc tubular construction.  
Back supports use 40mm pvc tubes.  
Easy to install.  
Includes net, clips and ground anchors.  
Comes in a carry bag.



### GOAL KEEPER REBOUNDER TRAINER

Light weight easy to use. Handheld.  
Test reactions of all goalkeeping ability.

- 3 **66599** 100 x 1000 mm.

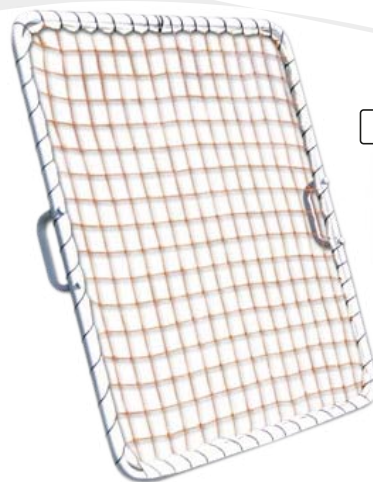

3





1



2

### VELCRO NET TIES

Quick ties connect, safe and easy method of attaching soccer nets.

1 **66411** white-pack of 40

### GROUND PEGS

2 **66191** 4mm metal peg. 8" long. - Set of 10

3 **66194** Plastic pegs. 6" long.

4 **66195** Plastic pegs. 8" long.

Set comprises: Heavy duty rubber mallet

40 x 7in steel pegs

80 fast clips & carry bag

5 **66418**

### FAST CLIPS FOR UPVC GOALS

6 **66421** Pack of 80.

### NET CLIPS

Fasclips are an easy to fit, time saving and tangle free method of attaching goal nets to posts.

7 **66422** Pack of 80.

### COUNTER BALANCE WEIGHT

17 kgs casted weight bags with chain & clips to hold soccer goals.

8 **66201** Blue colour

### RUBBER MALLETS

9 **66492** Heavy Duty.

### U-PEG ANCHOR

12 mm steel, chrome plated, Solid. Easy to use.

10 **66471** 460 mm long

11 **66472** 320 mm long, short model

6 mm steel, chrome plated, solid. Easy to use.

12 **66475** 200 mm U pegs

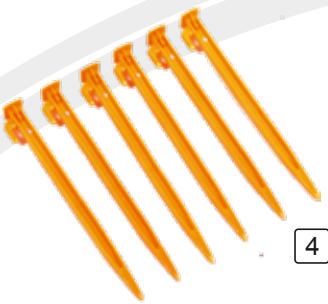

4

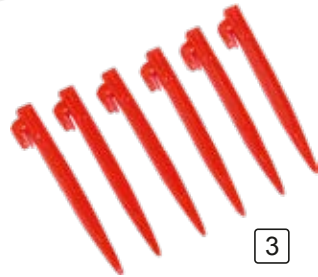

3



5



7

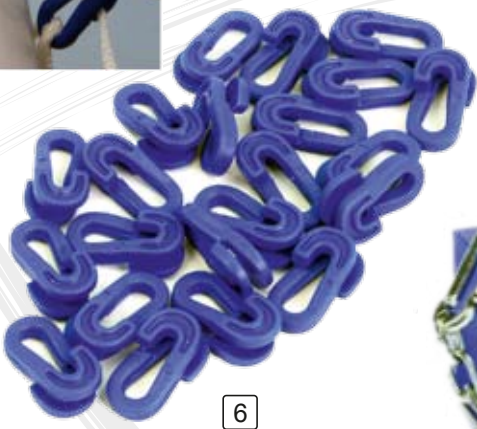

6



8



10

12



9



11



1 — 2



3

### BOTTLE CARRIERS METAL

Made of Steel Wire, PVC Coated.

- 1 **66151** Folding - For 6
- 2 **66152** Folding - For 8
- 3 **66155** Fixed  
New style, tapered. PVC coated.
- 4 **66157** Fixed- For 10
- 5 **66158** Fixed- For 6

### BOTTLE CARRIERS-PLASTIC

Plastic Bottle carrier for 6. Portable for easy transportation.

- 6 **66181** Bottle Carrier for 6
- 7 **66182** Bottle Carrier for 8
- 8 **66183** Bottle Carrier for 10

### SPORTS BOTTLES

Top quality Sports Bottles in Team colors.

- 9 **57655** With Fluid Level Gauge on side.  
Easy to open Screw lid.
- 10 **57656** Vectra Large.  
Quick release drinking nozzle prevents spillage.
- 11 **57657** Sporty XL with auto cap.
- 12 **57658** Sporty Small with auto cap.



4



7



6



5



8



9



10



11



12



# Whistles

# Soccer Training



## WHISTLES

Plastic - high impact, cork ball inside. 12Pcs box pack. Colours: Red, Green, Blue, White, Yellow, and Black.

- 1 **66301** Small - Supreme
- 1 **66302** Small - Standard
- 2 **66305** Large - Standard
- 3 **66307** Large - (#66305) with metal finger loop.
- 3 **66310** Small - Economy with plastic cork ball



Brass whistle, Natural cork ball, Nickel-plated. 12 Pcs box pack.

- 4 **66320** Small - 15grms
- 5 **66322** Medium - 20grms
- 6 **66323** Large 25grms.

Brass whistle, heavy duty, Natural cork ball, Nickel-plated. 12 pcs box pack.

- 7 **66331** Small - 20grms Length: 50mm
- 8 **66332** Medium - 28grms Length: 55mm
- 9 **66333** Large 37grms Length: 57mm
- 10 **66334** Ex. Large 40gms Length: 60mm



Steel whistle, Nickel plated with plastic ball.

- 11 **66336** Small
- 12 **66337** Large

Brass Scout whistle. Nickel - plated.

- 13 **66338** Heavy Duty - 30Gms Length: 80mm
- 14 **66339** Economy - 26Gms Length: 84mm

## LANEYARDS

4mm Braided nylon, 20" with snap-hook(2Pcs in each: Green, Blue, White, Black, and Yellow, & Red on Header Card.

- 15 **66351** New 20mm webbing lanyard, 20" with snap-hook
- 16 **66358**



## WHISTLE + LANEYARDS PROFESSIONAL PACK

- 17 **66381** 66301 + 66351 on Blister Card
- 18 **66382** 66305 + 66351 on Blister Card
- 19 **66385** 66320 + 66351 on Blister Card
- 20 **66386** 66323 + 66351 on Blister Card
- 21 **66391** Plastic whistle with cord string(#66356)in coloured box.
- 21 **66392** 66305 Plastic Whistle with cord string (#66356) in coloured box.

## WRIST LANEYARDS

- 22 **66360** New Compact Lanyard with Snaphook & adjuster.



17

18

19

20

21

22



## INFLATORS

New model. Plastic hand pump. 12" in header pack.

- 1 **66181**



1

## INFLATING NEEDLES

Z - level windshield

- 2 **66201** Double washer. Nickel plating. 2 mm  
 2 **66202** Double washer. Nickel plating. 2.50mm  
 2 **66203** Double washer. Nickel plating. 3mm

American Style

- 3 **66211** Steel Nickle plating.  
 3 **66213** Brass Nickle plating.

Supreme. European Style

- 4 **66221** Steel Nickle plating.  
 Needle adaptors with washer.  
 5 **66231** Short model 5mm threading  
 6 **66232** Short model 6mm threading  
 6 **66233** Long model 5mm threading  
 6 **66234** Long model 6mm threading



2

3

4

## PROFESSIONAL PACK FOR NEEDLES

3 - Needle on a card (American style #66211)

- 7 **66251**

3 - Needle on a card (European Style #66221).

- 8 **66252**

4 - Needle on a card (z-Level #66201)

- 9 **66255**



6

5

## STOCKING TIES

Black elasticated with velcro

- 10 **66273**

## REFEREE CARD

Referee Case: 18cm(L) x 15cm(W) Contains : - 1 each  
 Fluorescent Red & Yellow Card. - Score Pads, Writing Pads. -  
 Whistle, Lanyard, Toss Coin, pencil.

- 11 **66281**

Referee Wallets Contg. Fluorescent Red & Yellow Card (10 x 8cm) &  
 Score pads.

- 12 **66284**

Referee Cards in a pouch 1 each Red & Yellow card.

- 13 **66285** 10 x 8cms.



8

7

9



11



10

13



12





1



2



3



### ARM BAND - CAPTAIN

Elasticated, available in white/black, blue/white, red/white, yellow/white, green/white, black/white

- 1 **66401** Senior
- 1 **66402** Junior
- 1 **66403** Pupil



4

### ARM BAND - "C" - DIAMOND

Elasticated, diamond pattern, available in red/white, blue/white, black/white, green/white

- 2 **66405** Senior
- 2 **66406** Junior
- 2 **66407** Pupil

### ARM BAND "SPIELFUHRER"

Elasticated, available in white/black, blue/white, red/white, yellow/white, green/white, black/white

- 3 **66409** Senior
- 3 **66410** Junior



6

### ARM BAND "C"

Available in white, blue, red, yellow, green & black

- 4 **66413** Senior
- 4 **66415** Free size- With velcro closure.

### ARM BAND "ORDNER"

Identification Elasticated armband. Senior

- 5 **66419** white - 'Ordner'
- 5 **66421** white - 'Platzordner'



5

### ARM BAND - PLAIN

Elasticated, without print.

- 6 **66422** Black
- 6 **66420** White

### CAPTAIN ARM BAND 'INTERNATIONAL'

With adjustable velcro band. For others countries also available for request.

- 7 **66427** Turkey



7

### CAPTAIN ARMBND 'INTERNATIONAL'

Elastic band,

- 8 **66428** Germany
- 8 **66429** Netherlands
- 8 **66430** Hungary



9

### MULTIACTIVITY BAND

Elasticated multi activity bands numbered 1 to 9.

- 9 **66433** Black.



### BOUNDARY POLE BASE

Universal base, solid weighted rubber (2.900 kg)., Diameter 27cms to ensure stability. Suitable for PVC/wooden poles of upto 27mm diameter and synthetic poles with a diameter of 50mm are placed over the socket.

1 **66000**

#### Base Plate Rubber

Rubber base suitable for poles of 25 mm dia. Dia 23 cm, H: 5 cm

2 **66001** Black

3 **66002** Grey

### CORNER POSTS

4 **66011** 25mm PVC post 5ft. With Red Flag (50cm x 30cm), steel peg base.

White PVC boundary post 5ft., Flexible in all direction when pressure is released, the post returns to the Upright position with steel ground sleeves.

5 **66012** 25 mm Post

6 **66013** 20 mm Post

7 **66018** Collapsible design for safety and easy transport portable 5ft. Post with peg.

8 **66016** New 15mm strong fiberglass post with spring and metal peg to move in all directions.

### LINESMAN FLAG

9 **66051** Official "World Cup" model. PVC Stick with sponge grip & Hi-soft rotating diamond flag with carry bag.

10 **66052** 54cm Alum shaft with Hi-soft foam grip, chequered flag with Carry bag.

11 **66055** Regular linesman's flag. 1 yellow & 1 red, alum shaft with foam grip.

12 **66057** Stick only, Alum shaft with Hi-soft foam grip & metal Loop. 54cm.

### SOCCER FLAGS

Heavy duty Nylon, Red, Green, Blue, Yellow & White.

13 **66061** 380 x 300 mm.





# Bags

# Multi Storage

2



1



### BALL SACK

70D Nylon  
Draw cord closure & shoulder strap  
Dia 48cm X Height 90cm  
Colour: ●●●●●  
Holds 15 size 5 Balls

1 45001

### BALL SACK

70D Nylon with mesh ventilation panels to aid ball drying.  
Draw cord closure.  
Dia 48cm X Height 90cm  
Colour: ●●●●●  
Holds 15 size 5 Balls

2 45002

### BALL SACK

70D Nylon with mesh ventilation panels to aid ball drying.  
Draw cord closure strap.  
Free strip for the customized name on the front.  
Dia 48cm X Height 90cm  
Holds 15 size 5 Balls

3 45003

7



3



### BALL SACK

NEW STYLE

4 45004 Dia 85cm X 50cm. for 15 balls  
5 45005 Dia 75cm X 40cm. for 6/7 balls

### MULTI PURPOSE HOLDALL

Multi purpose holdall with a zip & handles, can be used for wide range of equipments.  
Holds 15 balls.  
Size : 90 x 40 x 40cms.  
Colour: ●●●●●

6 45011

4



5



### DUAL CARRY BAG

Multi Purpose Nylon bag to carry one Ball & pair of shoes with side Pocket.  
7 45075 Size : 42 x 30 cm.

### EQUIPMENT BAG

Versatile Sports Bag, featuring: 2 end pockets, zippers, water proofed bottom & shoulder strap.

8 45061 36 x 36 x 72 cms  
8 45062 26 x 26 x 60 cms

6



8





### JUMBO MESH BAG

Extra large bag with locking draw string. Can hold a wide range of sports equipment.

Colors : Red, Yellow, Black, White

- 1 **45051** 90 x 110cm Holds 20 Balls
- 1 **45052** 60 x 90cm Holds 10 Balls

### SHOE MESH BAGS

Mesh ventilation to aid shoes drying with locking string.

- 2 **45055** Small - 21x29 cms.
- 2 **45056** Large - 21x33 cms.

### BALL CARRY NETS

4mm White Braided nylon with locking draw string.

- 3 **45041** Holds 6 Balls, Blue String
- 3 **45042** Holds 10 Balls, Red String
- 3 **45043** Holds 15 Balls, Green String
- 4 **45045** Holds 4 Balls with loking draw string tube type.

### BALL CARRIER WITH HOOP

New way to Carry the Ball with hoop (14"). easy to fill and carry.

- 5 **45068**



### BALL CARRY NETS

3mm Green PE twisted with different color draw string.

- 6 **45021** Holds 4 balls, Red String
- 6 **45022** Holds 6 balls, Blue String
- 6 **45023** Holds 10 balls, Yellow String
- 6 **45024** Holds 15 balls, White String

2mm Orange PE twisted with different color string

- 6 **45031** Holds 4 balls, White String
- 6 **45032** Holds 6 balls, Blue String
- 6 **45033** Holds 10 balls, Yellow String

### BALL CARRY NETS For 1 Ball

- 7 **45036** 2.5mm Braided, Twin Color
- 7 **45037** 1mm PE Twisted, Twin Color





4

### BALL CART

Heavy duty Aluminium frame mesh liner.

1 **45959** 610 x 610 x 865 mm.

### BALL CAGE

Cage for 36 Balls. Strong & study code made of tublar steel.

2 **45961** 760 x 720 x 1020 mm.

### TEAM BASKET

Plastic coated wire storage basket, easily carried and ideal for various uses.

3 **57654** 470 x 31 x 265 mm.

### WHEEL CARRY BAG

4 **45965** Made of heavy duty fabric. A strong and sturdy bag which comes with wheels making it easy to transport

### MULTI PURPOSE CARRY BAG

Ball carrying bag made of heavy duty fabric. Comes with an adjustable shoulder strap.

5 **45968** For 5 Balls

6 **45969** For 3 Balls



2



1



3



6



5



1

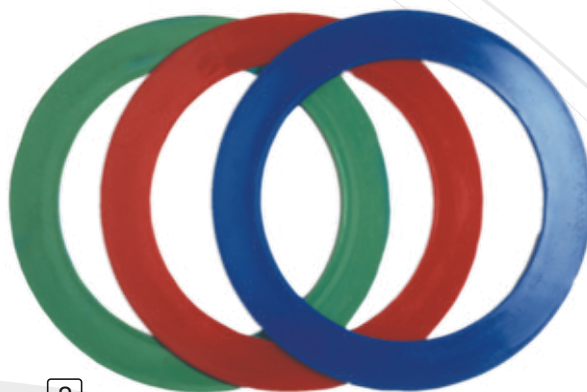

2

### JUGGLING SCARVES

The best way to teach juggling at every age. Available in Ten colour assortments: Red, Green, Blue, Sky, Orange, Black, Yellow, Pink, Purple & White.

- 1 **56101** 40 x 40 cms. - Individual
- 1 **56106** 66 x 66 cms. - Individual
- 1 **56111** 40 x 40 cms. - Set of 3
- 1 **56112** 66 x 60 cms. - Set of 3
- 1 **56113** 66x 66 cms. - Set of 10

### JUGGLING RINGS

Great juggling activity.

- 2 **56201** 24cm Dia, 70 gms - Set of 3

### SPINNING PLATES

Develop endless activities to focus on concentration. 9" (22.9cm) plate with the stick.

- 3 **56301** Individual
- 3 **56302** Set of 3 - blue, red & yellow.



3

### DANCE SCARVES

Scarves for dramatic movement & excitement in bright dancing colours.

- 4 **56601** 6 rainbow Colours. - 54" x 54" (1.40 x 1.40m) Set of 6.
- 4 **56611** 10 assortment of Colours. - 36" x 27" (91 x 70cm) Set of 10
- 4 **56621** 10 assortment of Colours. - 72" x 54" (1.80 x 1.40m) Set of 10.

### DANCE HOOPS

6 rainbow colour ribbons with transparent clear plastic hoop(5") for dance & creative movement

- 5 **56651** 12" Long ribbons - Pair
- 6 **56654** 24" Long ribbons - Pair



4



5

6



1

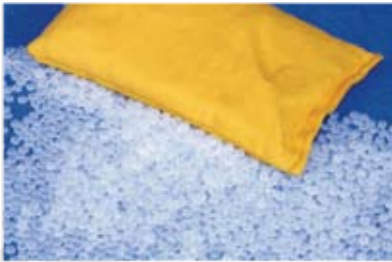

### BEAN BAGS - COTTON

In five brights colors (Red, Green, Blue, Yellow and Orange.) Strong Cotton drills, double stitched. Non toxic Plastic Pallets filled.

- 1 **60126** 10 x 10 cms 70 gms
- 1 **60127** 13 x 10 cms 113 gms
- 1 **60128** 15 x 10 cms 125 gms
- 1 **60129** 17 x 13 cms 230 gms
- 1 **60130** 20 x 15 cms 500 gms

Strong cotton drills, double stitched. Black Plastic pallets filled.

- 2 **60133** 15 x 10 cm 125 gms
- 2 **60132** 13 x 10 cm 110 gms
- 2 **60131** 10 x 10 cm 70 gms

### LONG LENGTH BEAN BAGS

Learning to catch in the four Primary colour. Also Suitable for special needs of children.

- 3 **60138** 28.50 cm x 7 cm 180 gms

### BEAN BAGS - NYLON

In four bright colors (Red, Green, Blue, Yellow) Strong nylon drills, double stitched, Black Plastic pallets filled.

- 4 **60135** 15 x 10 cms 125 gms

### PYRAMID BEAN BAGS

A Uniquely designed pyramid shaped bean bag, strong cotton drill in 4 team colors.

- 5 **60139**

### TARGET BEAN BAGS

A Uniquely designed pyramid shaped bean bag, strong cotton drill. Each face is stitched with round shaped Velcro, & hence does not matter from whichever side you throw

- 6 **60140**

### SOFT BEAN BAGS

PVC foam bean bags filled with Plastic Pallets.

- 7 **60141** 6" x 4" in 4 team colour

### Soft Bean Tubes

PVC foam Cubes with Plastic Pallets.

- 8 **60142** 5 cm Cubes
- 9 **60143** 7 cm Cubes



2



3



4



5



6

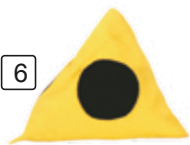

9



8



7





1

2

### ALPHA BEAN BAGS

A to Z Upper and Lower Case of Alphabets

1 **60145** Set of 26

### NUMBERED BEAN BAGS

1,2,3,4,5,6,7,8,9,0,00 for hundreds and 000 for thousands.

2 **60146** Set of 12

### COLOURED BEAN BAGS

Yellow, Blue, Green, Orange, Purple and Red.

3 **60147** Set of 6

### SHAPED BEAN BAGS

Shaped Circle, Triangle, Rectangle, Square, Diamond and Octagon.

4 **60148** Set of 6

### SEQUENCED BEAN BAGS

Numbered 1 to 9,0,00, and 000 to assist numerical skills in eight languages Strong cotton drill in 125 x 125 mm with Black Plastic Pallets filled.

5 **60149** 125 x 125 mm 110 gms



3



5



4





4

5

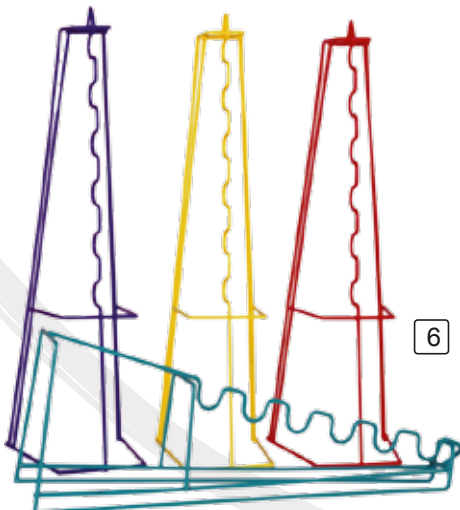

### SKIPPING ROPES-WITHOUT HANDLE

Cotton 10mm Braided Cotton Rope tagged with Black sleeves to prevent fraying(Pack of 10)

- 1 **60301** 1.83 M (6')
- 1 **60302** 2.13 M (7')
- 1 **60303** 2.43 M (8')
- 1 **60304** 2.74 M (9')
- 1 **60305** 3.05 M (10')
- 1 **60306** 3.35 M (11')
- 1 **60307** 3.66 M (12')
- 1 **60308** 5.48 M (18')
- 1 **60309** 7.32 M (24')

Plastic 6mm Reinforced Plastic Ropes without handles (Pack of 20 - 5 of each).

- 2 **60322** 2.13 M (7')
- 2 **60324** 2.74 M (9')

Jute 6mm Jute Rope tagged with Black sleeves at each end.(Pack of 10).

- 3 **60311** 1.83 M(6).
- 3 **60312** 2.13 M (7').
- 3 **60313** 2.43 M (8').
- 3 **60314** 2.74 M (9').
- 3 **60315** 3.05 M (10').
- 3 **60317** 3.66 M (12').

### BRAIDED ROPES-NYLON

8 mm Polypropylene Braided rope in 6 rainbow colours.

- 4 **60361** 2 M Length
- 4 **60362** 2.5 M Length

### BRAIDED ROPES-COTTON

8 mm cotton braided rope in 4 team colours.

- 5 **60367** 2 M Length
- 5 **60368** 2.5 M Length

### STACKER SKITTLE

Wire Unit Supports canes and loops in a vertical or horizontal position.

- 6 **60156** 760 mm (30")

### MULTI PLAY SKITTLE

- 7 **60157** 760mm (30")

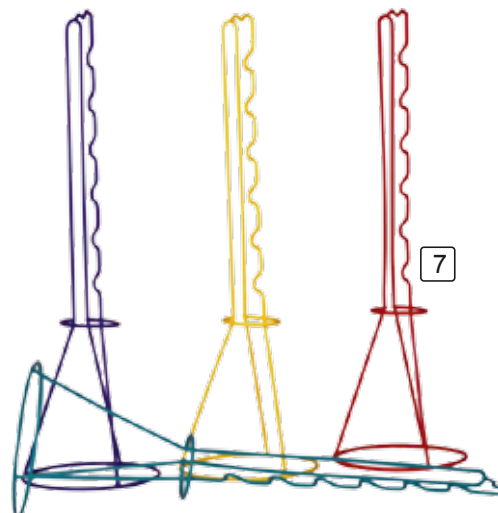



### PARACHUTES

Parachute play is a cooperative therapeutic activity made for young and old alike. Chutes have been specially designed for response and movement intrinsic to daily activities. Adults and children alike love parachute, not only for the social participation, the development of motor coordination, strengthening and exercise. heavily reinforced in all key stress areas with heavy duty handle and carry bag.

- 1 **60505** 1.8M – 8 panels – 6 handles – 6 Colors
- 1 **60504** 3.5M – 12 panels – 12 handles – 6 Colors
- 1 **60506** 4.0M – 12 panels – 12 handles – 6 Colors
- 1 **60503** 5.0M – 12 panels – 16 handles – 6 Colors
- 1 **60502** 6.0M – 16 panels – 20 handles – 4 Colors
- 1 **60501** 7.0M – 20 panels – 24 handles – 5 Colors



### TARGET PARACHUTE

Made of heavy duty nylon cloth, with 2 holes on each panels & points printed against each hole. Panels are in 4 colors for equally dividing them to the teams for targets. Comes with a carry bag.

- 2 **60509**



### RHYTHM FLAGS

For dances with the whole group, imaginative and creative motion pictures and motion for small muffle these flags have been invented. With the large loops can be the banners really keep swinging well, and put in motion. By sewn sand weights, and the handles the flags to remain at the wings behind the flag-wavers and fall smoothly. Nylon fabric with sewn Sandbag.

- 3 **60521** Set of 4, 48 x 48 cm, 75 g, assorted colors.



### TENNIS PLAY BALL

Colored, ideal for group Activities in the playground

- 4 **60410**

### RUBBER PLAY BALL

Sponge rubber

- 5 **60411** Rainbow color 63mm (2½") 85gms
- 5 **60412** Rainbow color 63mm (2½") 120gms
- 5 **60413** Single color 63mm (2½") 85gms
- 5 **60414** Single color 63mm (2½") 120gms
- 5 **60415** Rainbow color 75mm (3") 180gms
- 5 **60416** Single color 75mm (3") 180gms



### TENNIKOIT RINGS

Traditional soft rubber Quoils suitable for throwing, catching & target activities. Both indoor & outdoor.

- 6 **60421** 190 - 200 gms. 7" (180 mm)
- 6 **60422** 230 - 240 gms. 7" (180 mm)

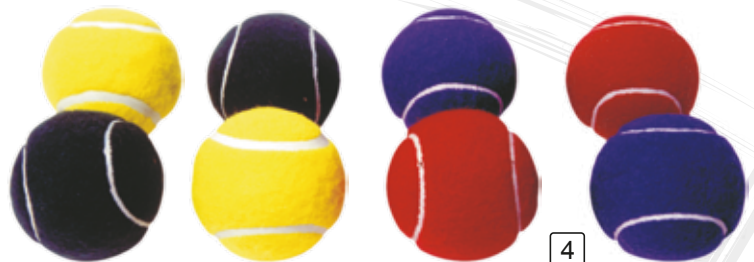



1

### TARGET TOSS

8 Bean bags & 1 PVC coated Target (100x100cm). Easy to play target game. Set your own distance and compete over a set number of throws.

1 60530



2

### FRISBEE

Flying disc in 4 team colours.

2 60511 Large : 27 cms

3 60512 Small : 22 cms



3



4

### CLIMBING ROPES

Heavy duty hemp rope to build upper arm and shoulder strength. Fitted with metal hook on top and rubber Sleeves bottom. 36 mm dia. Ideal for P.E. program.

4 60541 4.0 M Long

4 60542 4.5 M Long

4 60543 5.0 M Long

4 60544 5.5 M Long

4 60545 6.5 M Long



5

### PENNANT COLOURED

Water resistant Nylon Pennants in 4 team colours, 12" Long ideal for school festivals and fetes for Indoor & Outdoor.

5 60551 10 M Length.



4



### MULTIACTIVITY ROPES

Use for many games, as a jump rope, for gymnastic exercises, and various kindergarten activities for playing, making various object comes in four basic colors.

1 **60451** Rope length varying 50 cms. to 2 meters - 2 Kg.

### WEIGHTED POUCH SCARVES

Soft touch weighted mini pouches give these chiffon scarves a defined trajectory which aids catching.

2 **60007** Set of 6.

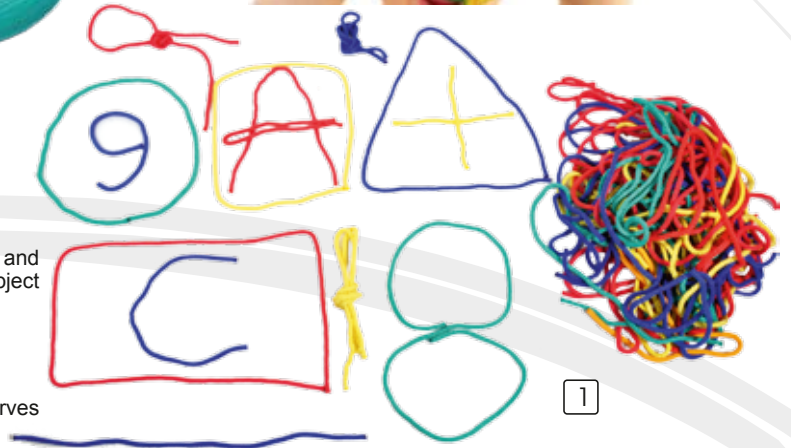

1

### HORSE BELT

The classic game of little horse being dug out for you again. The straps are adjustable to fit you comfortably. The buckles in the front can be opened anytime if the horse is to escape.

3 **60001** Set of 6.



2

### SOFT FRISBEES

4 Soft Frisbee Ø 18 cm.

### JUMPSACKS

Both sizes of our Hopsackers sets with a full educational array. Each set of six bags consists of one each of the three primary and secondary colors, and bold numerals one through six. Each number is further supported by dot sets and words in English, Spanish and French. Super-stitched the seams for durability, provided 2 easy-grip handles.

5 **60008** SMALL. 25"Hx11"Lx11"W sets of 6.

5 **60009** LARGE 30"Hx13"Lx13"W sets of 6.

### PLAY STILTS

H: 12cm, Dia: 10.5cms.

6 **60011** For training of balance and coordination skills of hand and feet movement as will be developed.



3



6



5



### TEAM SASHES

5 cm polypropylene webbing, specifically designed for younger students in elementary school-six rainbow colors.

- 1 **60181** Junior 48cm
- 1 **60183** Senior 60cm

### DELUX VELCRO CLOSED END

- 2 **60184** Senior 60cm

30 mm Polyester sashes in six rainbow color.

- 3 **60165** 50cm long
- 3 **60166** 60cm long

30 mm Cotton sashes in 4 team colors.

- 4 **60169** 60cm long

### PLASTIC SASHES

30 mm wide. Unbreakable welded joint in 4 team colors.

- 5 **60164** 52cm long

### METAL RING HOLDER

6 **60167** Ideal way to carry sashes.

- 6 **60154**

### IDENTIFICATION BELT

New way to identify a team. 41" Length X 35" Width. Perfect for scnod activities.

- 7 **60190** velcro closure in 6 color.

### TEAM BRAIDS

An economical way to make your own team sashes. One roll can make 12 team sashes.

- 8 **60161** 30mm. Wide - 11m.
- 8 **60162** 38mm. Wide - 11m.



2

6

4

3

5

8

7



1



2



3

### TUG OF WAR ROPES

Superior manila twisted rope, Ends reinforced with Leather to Prevent fraying. Specific Length available.

- 1 **60575** Senior 30 m x 36mm dia
- 1 **60576** Junior 22 m x 24mm dia

Polypropylene rope strong enough to be used in junior tug of war game. Provides a good grip but is softer for the hands

- 2 **60578** 20mm x 20m length

Attractive color soft rope in unique constructions in a surface. Easy to grip for fair starts and eliminate arguments the rope has a permanently attached 60cm centre start point.

- 3 **60579** 22.5 mm.



4

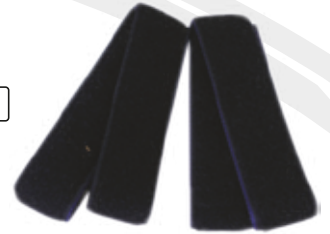

### THREE LEGGED RACE

Leg ties with velcro fasteners for three legged races.

- 4 **60551** 60 cms long x 38 mm wide

### PLAY TAG BELTS

Exciting game providing healthy exercise of all age groups. Adjustable belt, waists upto 35". develops agility, speed and balance.

- 5 **60556** For 12 Players(6xRed, 6xBlue)
- 5 **60557** For 12 Players(6xYellow, 6xGreen)

### JUMPING SACKS

Heavy nylon with grab handles, 60cms high with 27 cm diameter base.

- 6 **60581** 4 Team Colors

### COTTON SCARVES

In 6 rainbow colour - Red, Green, Blue, Yellow, Orange & Purple.

- 7 **60586** 50x50x80cms Cotton Pack/6
- 7 **60587** 50x50x80cms Nylon Pack/6



5

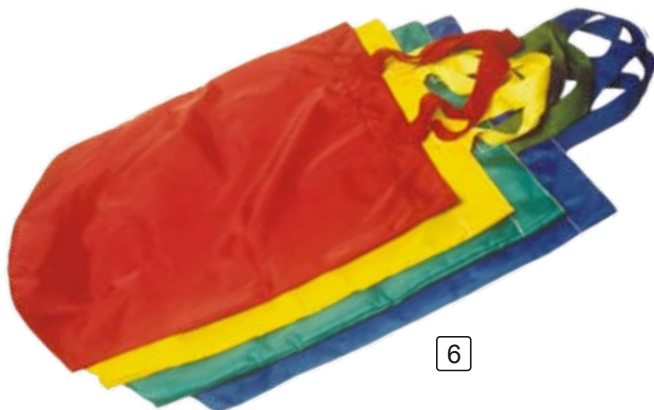

6

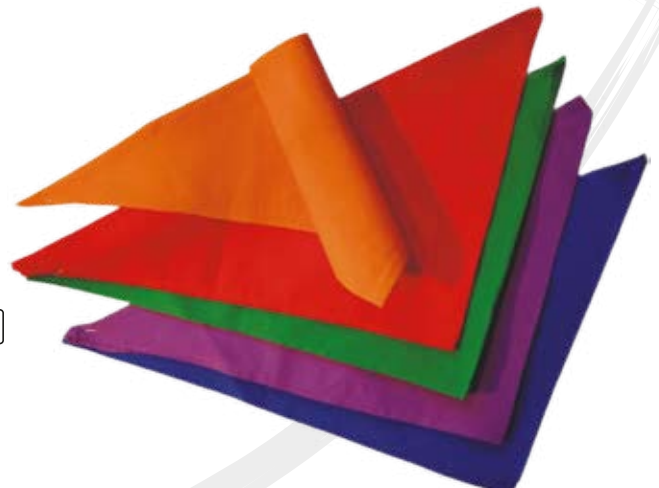

7



# Primry Play

# Activity Play

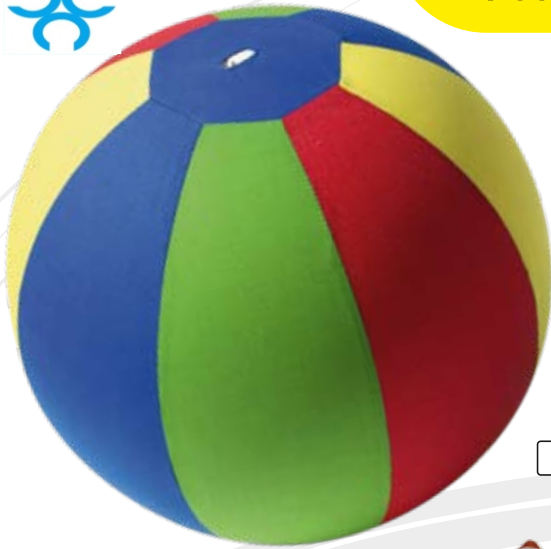

1



2

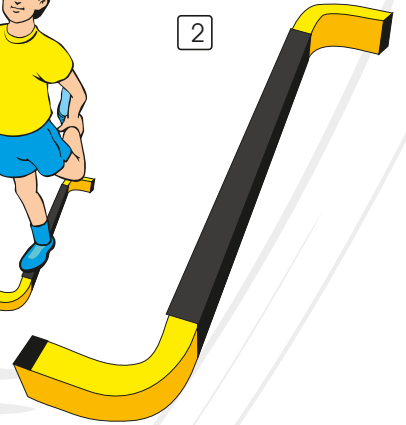

### KID BALL

Light-weight ball Ideal for collective and cooperative games, such as catch. Made of Coton cloth with latex bladder. Can be filled to various pressures according to the desired use. Colour: Blue/Red/Yellow/Green Diameter 75 cm.

- 1 60041 Cloth cover, 3 Ballons & blower.
- 1 60042 Nylon cover, 3 Ballons & blower.

### BALANCING BEAM

Introduced into FUN IN ATHLETICS and the MILLENNIUM YOUTH GAMES as a test of balance. Steel section with carpet covering. Measure complete 2 trials on each leg for a maximum of 15 seconds each.

- 2 60045

### WALKING ROPE

Sturdy nylon webbing 8' 6 L (104inch). walking rope has 12 easy-grasp, differently-colored handles and a large loop handle on each end for teachers to share with a child. Use this handy tool to keep children safe on field trips, crossing the street, or going down the hallway. Includes a sewn-in velcro strap to attach additional ropes to accommodate more children.

- 3 60044

### MEASURING MAT

This easy to read roll out scale allowing quick measurement for throwing activities. Its ease of use allows many participants to take part during a short period of time. Perfect for use in Shot, Javelin, Discus and Hammer.

- 4 60046 10 Meters.

### WALKING BEAM

Balancing curved walking beama in assorted colors. Set of 12 - 3 of each in Red/Yellow/Blue/Green

- 5 60049

### RUGBY BALL SOFTY

Vinyl cover, polyester filled softy ball for Multi activity with full of fun.

- 6 60431 200mm

### FOOTBALL SOFTY

Vinyl cover, polyester filled softy ball for Multi activity with full of fun.

- 7 60434 150mm
- 8 60435 125mm



3

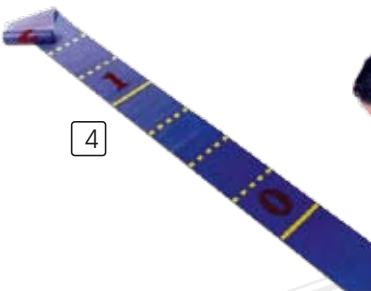

4



5



6



7



8



### NUMBERED MARKER CONES

New way to Learn. Numbers and colors through active play. Set of 10.

- 1 **60301** 9" Heavy Duty Cones 1 to 9,0
- 1 **60302** 9" Light weight Cones 1 to 9,0



1

### MATHEMATIC MARKER CONES

New way to Learn with fun and play. Set of 5

- 2 **60307** 9" Heavy Duty Cones for Mathematic skills.

### SYMBOL MARKER CONES ARITHMETIC

New way to Learn with fun and play. Set of 5

- 3 **60306** 9" Heavy Duty Cones Symbols +, -, =, x,

### ALPHABET MARKER CONES

New way to Learn Alphabets through active play. Set of 26

- 4 **60305** 9" Heavy Duty Cones A to Z



2

### BALL BATS

Wooden natural lacquered with grip.

- 5 **60391** Round 700 mm
- 5 **60392** Round 600 mm
- 5 **60393** Flat 500 mm

### NUMBERED NYLON BIBS

Both Side printed heavy duty nylon Bibs. Learn numbers through active Play. One side elastic otherside Velcro.

- 6 **60310** 40 x 45 cms - 1 to 10

### ACTIVITY HOOPS

Multi activity colorful hoops.

- 7 **60047**



3



6



4



5



7





# Traditional Indoor Games

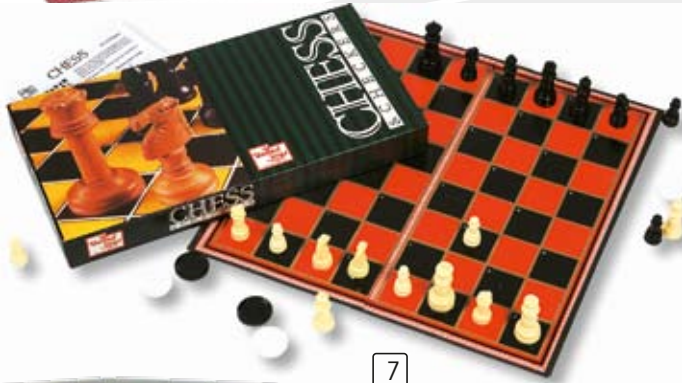

7

3

4



5



6

## LUDO & SNAKES AND LADDERS

**1 53110** Deluxe model, a game that has been around for centuries! An evergreen game for kids where the lucky one landing on a ladder space climbs up and the unlucky one landing on a snake's mouth takes the down hill path. Also included is the traditional game of ludo (4 Players).

## LUDO for 6 players

**2 53115** The traditional game - A group of 6 players can play.

## JENGA

**3 53121** Build and balance game.

The tower of jenga built with wooden blocks. The one and only rumbling, tumbling, crumbling, crashing tower building game of suspense. The last player to stack a block without making the tower tumble over wins.

## JENGA JUNIOR

**4 53122** APT FOR YOUNG MINDS WITH BIG DREAMS!

A fun packed action game with attractive small wooden blocks. The game ends when the tower falls in even a minor way—in other words, any piece falls from the tower, other than the piece being knocked out to move to the top.

## CHESS

**5 53125** The classic strategy game representing medieval warfare on an 8x8 board with alternating light and dark squares.

## CHESS - Hard Board

Strengthened Hard Board with chessmen.

**6 53126** 12" x 12"

**6 53127** 14" x 14"

**6 53128** 18" x 18"

## CHESS AND CHECKERS

**7 53113** Two classic games brendled in one box.

# Indoor Games Traditional



1

## MONOPOLY

1 **53001** The world's best property trading board game where players vie with each other to amass the maximum wealth to be the winner.

## JUNIOR MONOPOLY

2 **53002** Simplified version of the world's most popular game. The game board has a carnival like atmosphere and players have a great time making or losing money.

## MONOPOLY AMERICAN VERSION

3 **53003** Dabble in business the way America does Buy, sell, mortgage and build houses and hotels. Collect rents and grow rich and see the adventurous side of life as you get in and out of jail. Get smarter – and get cracking with the most widely played board game in the world!

## SCRABBLE - Original

4 **53011** The classic word game with every element, inside and out been redesigned to improve the experience of playing the game where EVERY WORD COUNTS!

## SCRABBLE JUNIOR

5 **53012** The children's version of the classic word game. The new look, double-sided board includes "Words and Pictures", a simple game of word recognition and a brand new, easy to play game for older children Similar to classical Scrabble. For ages: 5-10 years

## PICTIONARY ADULT CLASSIC

6 **53031** Pictionary is the game of quick draw, where your pencil does the talking, while you and your team try to guess the words by sketching clues to each other. Be prepared to race against the clock! How much fun you have depends on where you draw the line!

## PICTIONARY JUNIOR

7 **53032** The simplified version of the parent game, designed for a younger audience. The cards contain simpler topics, more suitable for children. The Game for quick draw for Juniors.

## UPWORDS

8 **53044** A great 30 word building game where players compete with each other to build words sideways and upwards.

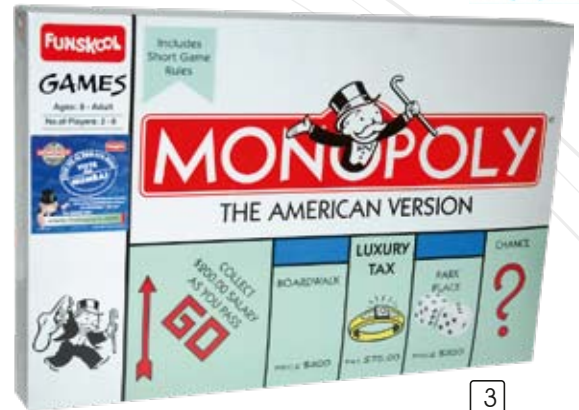

3

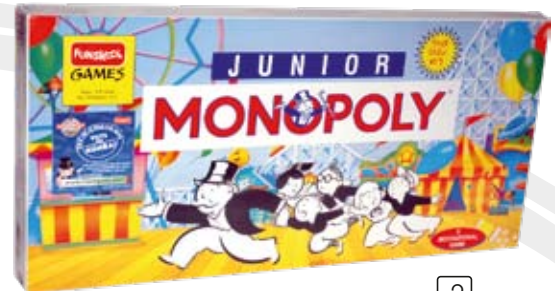

2



4



5

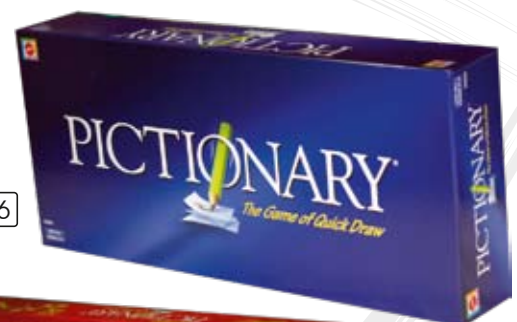

6



7

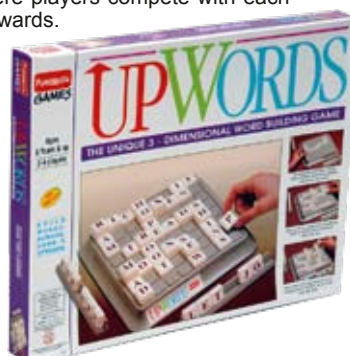

8



Trainer

# Tennis Rebounders



## TENNIS REBOUNDER

The tennis rebound trainer is an excellent piece of kit that allows you to practise full blooded shots in relatively confined space. It is excellent for building up arm strength and is also very useful for warming up prior to playing.

2.7M X 2.2M

- 1mm x 31.8mm Coated Steel Frame
- 30ply Twisted Polyethylene Twine
- 1" Mesh
- 4 Angle Adjustments
- Orange Height Indicator Tape
- 42x Elasticated Ties
- Weight = 14KG

1 **97003**



## COMPACT SHORT TENNIS

Heavy duty construction complete with net. Free standing portable, take anywhere tennis net system. Fabricated from sturdy aluminium.

2 **97001** Size: 3 mm wide

3 **97002** Size: 6 mm wide



### TCHOUK ball for FUN & Leisure

Used for Tchoukball official game or rebound reaction games

Free standing frame

Fitted with anti slip floor guards

Strong reaction net 70 x 70cm

**mesh size: 4.5 x 4.5 cm, ø 3 mm**

**Dimensions: 1m x 1m**

**33mm C.I steel frame, powder coated.**

1 TX-100 – Fixed angled at 55°

1 TX-150 – Adjustable

**33mm G.I galvanized zinc plated frame, powder coated.**

2 TX-200 – Hi-Tec - Fixed angled at 55°

2 TX-250 – Hi-Tec – ADJUSTABLE

**3 25mm C.I. Steel Frame, Powder Coated**

TX-80-Fixed angled at 55°

**Dimensions: 80 x 80**

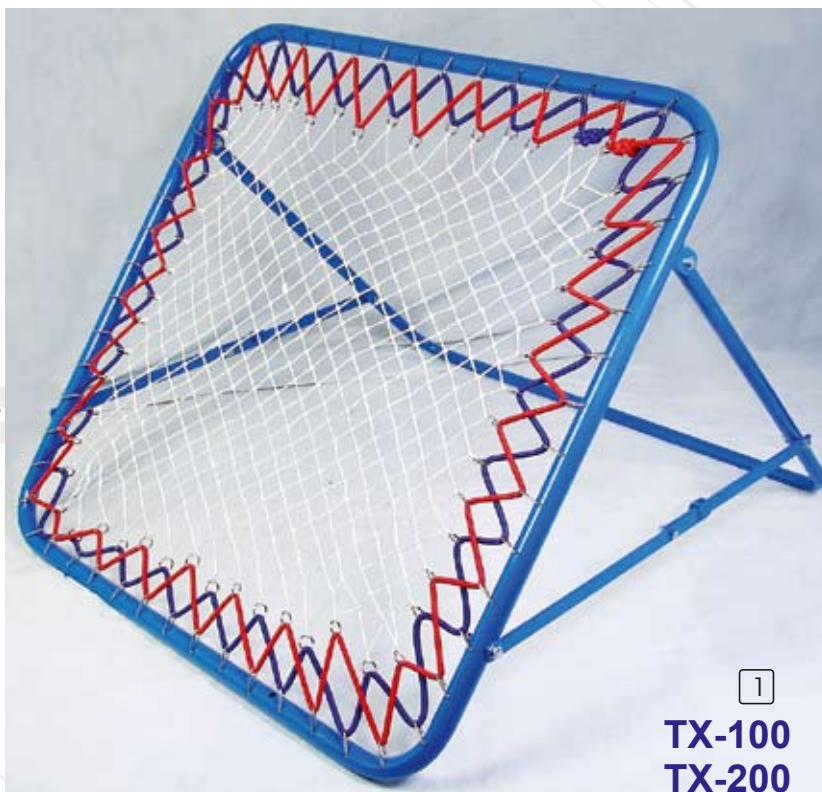

1

**TX-100  
TX-200**

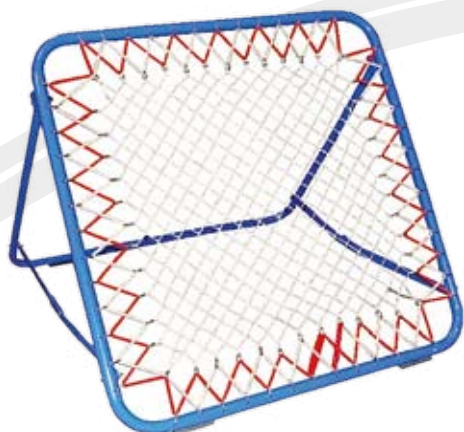

3

**TX-80**



X

2

**TX-150  
TX-250**



1



2



3



4



5

### STICK CARRYING BASKET

White plastic coated steel mesh, holds upto 9 sticks.

- 1 **80351** 185 x 185 x 38cm height. Without divider.
- 1 **80352** With dividers.

### ROUNDER STICKS

460 x 50mm, made of white wood.

- 2 **80101** Cord bound handle.
- 3 **80102** Cord bound handle & rubber grip.
- 4 **80112** Flat model, cord bound handle.
- 5 **80113** Flat model, cane handle & cord bound handle

### ROUNDER BALLS

A range of hand stitched balls

- 6 **80201** Match - Designed for match used wonder ball with wool & cotton layering on to a cork center. Natural chrome leather red stitching.
- 7 **80202** School - A quality leather ball with a cork center White painted black stitching.
- 8 **80203** Practice - A practice ball with a cork center. White painted black stitching.



6



7



8

### POST & BASES

A Solid rubber bases with a inner diameter of 25mm Black.

- 9 **80310** 25mm White plastic posts (1220mm long with close end.) White Pvc post.
- 10 **80316** 25mm wooden posts with safty cap.
- 10 **80318** 1220 mm.



8

9

### ROUNDER SET

- 11 **80325** Excelent senior rounders pack.

Contents :

- 4 x 80102 Bat.
- 2 x 80201 Match Ball.
- 2 x 80204 Safty Ball.
- 4 x 1.2 m wooden Pasts with safty caps.
- 4 x 80310 Rounder Bases.
- 1 x rounders bag.

### ROUNDERS SAFTY CAP

Post co to fit 24 mm (1") rounders Pole. For extra visibility and safty.

- 12 **80401** Black



12

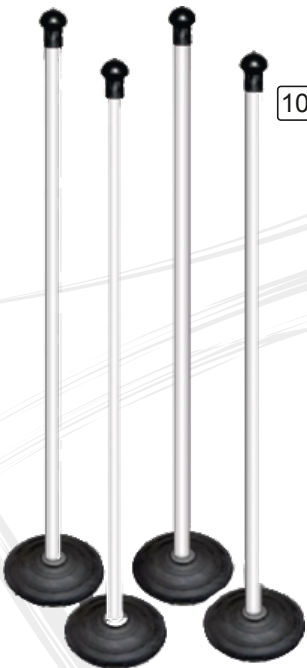

10



11



2



1



3

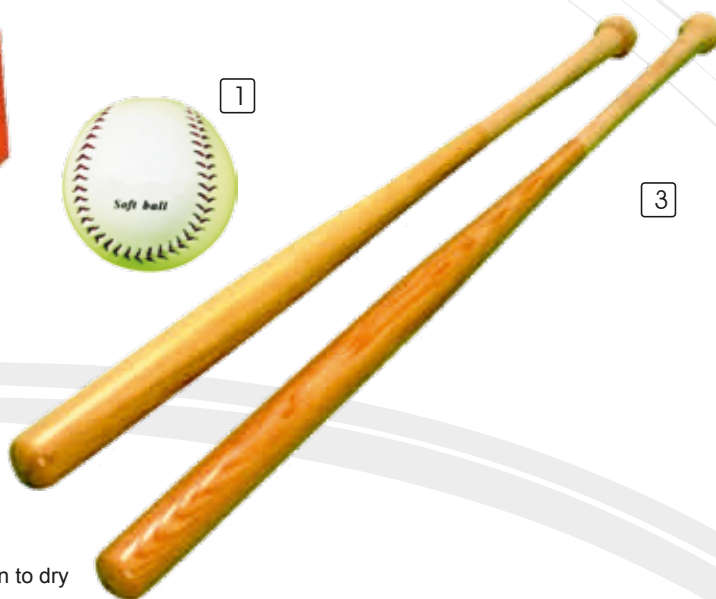

### SYNTHETIC TRAINING SOFTBALL

Synthetic covered ball with cork centre  
Red stitch.

Official size & weight Ideal training ball

1 **61101**

### INDOOR BASES

Throw down orange bases. Smooth rubber gives adhesion to dry floor surfaces.

2 **61102** Set of 5

### SOFTBALL BAT

Top quality practice bat. Wooden.

3 **61105** Senior 865mm (34")

3 **61106** Junior 735mm (29")

### PADDED SOFTBALL BASES

3 foam filled bases with straps and ground pegs.

4 **61107** 380mm x 380mm 76mm (15" x 15" x 3")

### PITCHERS PLATE

Heavy duty rubber with screw-in ground pins.

5 **61108** 457mm x 100mm (18" x 4")

### FIELDERS MITTS

Leather palm with leather back and lined wrist strap.

6 **61121** LEFT HAND - 12" SENIOR

6 **61122** RIGHT HAND - 12" SENIOR

6 **61123** LEFT HAND - 11" INTERMEDIATE

6 **61124** RIGHT HAND - 11" INTERMEDIATE

6 **61125** LEFT HAND - 10" YOUTHS

6 **61126** RIGHT HAND - 10" YOUTHS

6 **61127** 9 1/2" LEFT BOYS

4



6

5





1

**GISCO Mega Ultra - Senior - Field**

1 **51125** Reinforced Super glass fiber  
Head : Shorty  
Length : 36", 37"  
Weight : L, M, H  
Grip : Black



2

**GISCO Thunder - Senior - Field**

2 **51126** Without Fiber  
Head : Shorty  
Length : 36", 37"  
Weight : L, M, H  
Grip : Black



3

**GISCO Kids - Junior - Field Practice**

3 **51127** For Kids  
Head : Shorty  
Length : 27", 30",32",33",34"  
Weight : L, M  
Grip : Red



4

**Speed King - Senior - Field Learners**

4 **51129** Trainer stick with professional look.  
Head : Shorty  
Length : 36", 37"  
Weight : L, M, H  
Grip : Towel cotton grip



5

**GISCO Indoor - Senior - Indoor**

5 **51130** Reinforced with super fiber  
5 **51131** Without fiber  
Head : Shorty  
Length : 33",36",37"  
Weight : L, M, H  
Grip : Hi-soft Black



1



**GISCO Titan Senior Field**

1 **51120** Reinforced Super glass fiber with epoxy paint  
 Head : Special midly Laminated  
 Length : 36", 37"  
 Weight : L, M, H  
 Grip : Control Black

2



**GISCO Golie - Senior Field Goalkeeper**

2 **51121** Reinforced Super glass fiber with epoxy paint  
 Head : Special midly Laminated  
 Length : 35", 36"  
 Weight : L, M, H  
 Grip : Control Black

3



**GISCO Hot Shot - Senior Field**

3 **51122** Reinforced 40% cavlar, 20% carbon, 40% fiber.  
 Head : Middy Laminated  
 Length : 36", 37"  
 Weight : L, M, H  
 Grip : Hi-soft Black

4



**GISCO Astro - Senior Field**

4 **51123** Reinforced 60% carbon, 40% glass fiber.  
 Head : Middy Laminated  
 Length : 36", 37"  
 Weight : L, M, H  
 Grip : Hi-soft

5



**GISCO Mestro - Senior - Field**

5 **51124** Super glass fiber  
 Head : Special midly Laminated  
 Length : 36", 37"  
 Weight : L, M, H  
 Grip : Black





# Equipments

# Hockey



8



1



DIMPLE-JAZZ



DIMPLE



PLAIN



PLAIN-JAZZ

### HOCKEY HELMET

New style protective helmet, fully adjustable for any age group. Throat protection with foam padding.

1 51451

### HOCKEY BALLS

Poly Vinyl truf ball. Vulcanized Moulded core cadet from Hi-Tech cork and rubber nucleus. Seamless.

Colors : Red, Blue, Yellow, White, Green, Pink & Jazz

2 51223 Gisco Bronze Dimple

2 51233 Gisco Bronze Plain

3 51222 Gisco Silver Dimple

3 51232 Gisco Silver Plain

4 51221 Gisco Gold Dimple

4 51231 Gisco Gold Plain

### PROFESSIONAL MODEL

Light weight cross-linked foam moulded protective equipment for professional player. Extra strong (32mm) in different color.

5 51321 Moulded Legguards with kickers

6 51323 Gloves with sponge padding

7 51324 Chest Guard

8 51325 Metalic fiberglass helmet fitted with high density foam adjustable

### CLASSIC MODEL

Light weight foam moulded protective equipment for clubs & schools. Thickness (27mm) in different color.

9 51331 Moulded Legguards

10 51332 kickers

11 51334 Chest Guard

### HOCKEY GLOVES

Eva moulded gloves classical model.

12 51341

### HOCKEY BALLS

13 51237 Olympic Special - Practice.



7

6

5



9



10

12

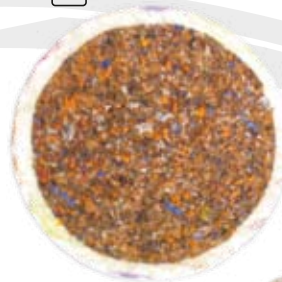

2



3



11



4



13





1



### SHINGUARD - EVA

Light weight foam moulded. Padded with elastic and velco.

1 **51410**

### SHINGUARD

Shaped Plastic shinguard with Eva back

2 **51412** Senior

2 **51413** Junior

2



### SHOULDER GUARD WITH SHORTS

A set of Professional Protection Kit Featuring:  
Light weight eva moulded with Lycra facing.  
Full Protection to upper torso with extra Padding on shoulder  
Shorts with foam Padding for thighs and Kidneys.

3 **51421**

4

### HOCKEY DISCIPLINE CARDS

Made from Polystrol. International set consiting of : 1 red card (round), 1 yellow card (square), 1 Green card (triangular) in pouh.

4 **51239**



3



2

1

3

VALVE A



VALVE B



VALVE C



### RUGBY BALLS

#### GISCO Premium

All weather proof synthetic, Superior Grip for performance in all weather conditions. It is balanced for perfect flight characteristics.

- 1 **44201** Senior 440 gms., Junior 410 gms., Size 3 380 gms.

#### GISCO Club

All weather proof synthetic with pimple grains, 3ply canvas lining.

- 2 **44202** Senior 440 gms.
- 2 **44203** Junior 410 gms.
- 2 **44204** Size 3 380 gms.

### LATEX BLADDER FOR BALLS

- 3 **44502** Soccer Ball 70 gms.
- 3 **44503** Soccer Ball 80 gms.
- 3 **44504** Volley Ball Size 4
- 3 **44505** Soccer Ball Size 3
- 3 **44506** Rugby Ball 80 gms.

### RUGBY KICKING TEES

- 4 **44858** Kick-off Tee
- QUICKER KICKER**
- 5 **44859** Ideal entry level kicking tee.
- PRECISION TEES**
- 6 **44852** Available in 2 heights to suit individual requirements.
- 7 **44853** Various height adjustment telescopic.
- ADJUSTABLE KICKING TEE**
- 8 **44854** Adjustable from 60 mm to 90 mm.
- 9 **44860** Convert Kicking Tee 1"



10

12

### CONTACT SUIT

- 10 **44881** Universal Size  
Reinforced highly durable body armour suit. Ideal for heavy tacking practice. New reversible design. Durable nylon.



4



9



5

### HEAD GUARD

- 11 **44885** Size : Large
- 11 **44886** Size : Medium  
A superb ultimate head guard to give maximum dimension cranial protection.



6



7



8

### SHOULDER GUARD VEST

- 12 **44887** Universal Size  
Lycra, elastic closing with Shoulder Protection.

### RUGBY CHEST GUARDS

- 13 **44889** Universal Size  
A superb soft Eva chest guard with full protection.



11

13



### MOUTH GUARDS

Strapless sports mouth guards in transparent/colored box.

- 1 **44801** Senior - Super pro colors
- 2 **44802** Senior
- 3 **44803** Junior
- 4 **44805** Double Impressions
- 5 **44806** Baby
- 6 **44808** Junior - New design
- 7 **44809** Senior - New design
- 8 **44811** Senior - Super Deluxe Tri Color
- 9 **44812** Xlarge



### TAG RUGBY BELTS

Ideal team sport for all age groups. Non contact game of rugby, players each wear a velcro belt with two tags attached which have to be pulled off by the opposition team to denote a tackle also a constructive non-contact training aid.

- 10 **44870** Senior
- 11 **44871** Junior
- 12 **44872** 45" Standard Teg Belt
- 13 **44873** Spare Teg (Only, with velcro 16" x 2")

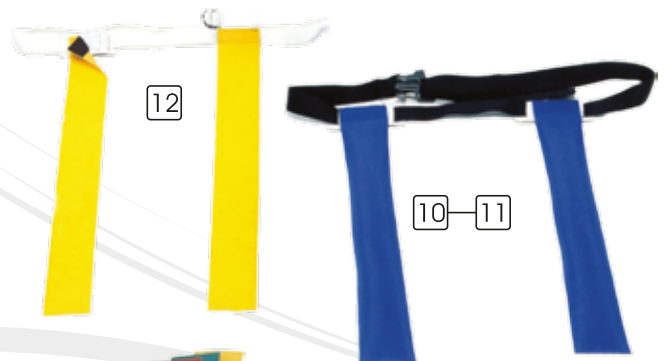

### RUGBY GLOVES

An Ultimate lycra glove with grains on back

- 14 **44895** Size : Universal.

### RUGBY TRAINING BIBS

Cotton drill. Heavy duty 3" elastic at both sides.

- 15 **44894** Size (XL/L/M/S)
- | Size   | XL | L  | M  | S  |
|--------|----|----|----|----|
| HIGHT  | 62 | 55 | 50 | 36 |
| LENGTH | 50 | 40 | 36 | 32 |





### SCHOOL HURDLE – SCHOOL

Adjustable Height and folding legs for easy transport with

Plastic crossbar top.

1 **59805**

### GISCO PRO HURDLE

Strong hurdle made of 47mm Steel tube with Polyurethane Painted. Counter weight adjusts to meet precise pull over force at each of the four heights. Height range: 0.762M to 1.067M.

2 **59801**

### GISCO SCISSOR - ROUND

Made of round steel tubular pipe. Height range 9" to 36" with wooden bar

3 **59810**

### HIGH JUMP STAND

1½" Tubular Steel Construction weighted T-shaped base. Marked 76cm to 207cms Plastic calibrated strip. Weight: 4.500kg. aluminum risers.

4 **59876** Steel uprights.

4 **59877** Aluminium uprights.

1

2

3

4



### SUPER SPIN - BRASS RIM

Strong Black Plastic sides with Brass rim for firm grip. High Percentage weight distribution on the Rim

- 1 **59104** 1.00 Kg.
- 1 **59106** 1.50 Kg.
- 1 **59108** 2.00 Kg.

### SUPER SPIN - S/S RIM

Strong Black Plastic sides with Stainless Steel rim for firm grip. High Percentage weight distribution on the Rim

- 2 **59114** 1.00 Kg.
- 2 **59115** 1.50 Kg.
- 2 **59117** 1.61 Kg.
- 2 **59119** 2.00 Kg.

### HIGH SPIN - STEEL RIM

High Spin Blue plastic Discus with steel rim for gripping. More than 75% weight in the rim.

- 3 **59134** 1.00 Kg.
- 3 **59135** 1.25 Kg.
- 3 **59136** 1.50 Kg.
- 3 **59137** 1.61 Kg.
- 3 **59138** 1.75 Kg.
- 3 **59139** 2.00 Kg.

### LO SPIN - STEEL RIM

Lo-Spin Red Discus. Strong Plastic Plates. Unsurpassed durability at economical price. Less weight in the Rim.

- 4 **59121** 0.600 kg.
- 4 **59122** 0.750 kg.
- 4 **59123** 0.800 kg.
- 4 **59124** 1.00 Kg.
- 4 **59125** 1.25 Kg.
- 4 **59126** 1.50 Kg.
- 4 **59127** 1.61 Kg.
- 4 **59128** 1.75 Kg.
- 4 **59129** 2.00 Kg.

### SUPER 1000

Laminated LO Spin Olympic model. Solid. Cross Laminated wood. 70% or less weight in rim.

- 5 **59142** 0.750 kg.
- 5 **59144** 1.00 Kg.
- 5 **59145** 1.25 Kg.
- 5 **59146** 1.50 Kg.
- 5 **59147** 1.61 Kg.
- 5 **59148** 1.75 Kg.
- 5 **59149** 2.00 Kg.

### SUPER 500

Wooden Official Olympic Model. Made from seasoned Sheesham Wood. Official size and weight.

- 6 **59154** 1.00 Kg.
- 6 **59155** 1.25 Kg.
- 6 **59156** 1.50 Kg.
- 6 **59157** 1.61 Kg.
- 6 **59158** 1.75 Kg.
- 6 **59159** 2.00 Kg.



1



2



4



5



3



6





# Discus

# Track & Field

1



### POPULAR

Wooden Practice

Made from seasoned Sheesham wood with steel rim for practice.

- 1 **59191** 0.600 kg.
- 1 **59192** 0.750 kg.
- 1 **59194** 1.00 Kg.
- 1 **59195** 1.25 Kg.
- 1 **59196** 1.50 Kg.
- 1 **59197** 1.61 Kg.
- 1 **59198** 1.75 Kg.
- 1 **59199** 2.00 Kg.

2



### RUBBER - BLACK

For training, accurate weight, Solid Rubber.

- 2 **59169** 0.350 kg.
- 2 **59170** 0.500 kg.
- 2 **59171** 0.600 kg.
- 2 **59172** 0.750 kg.
- 2 **59173** 0.800 kg.
- 2 **59174** 1.00 Kg.
- 2 **59175** 1.25 Kg.
- 2 **59176** 1.50 Kg.
- 2 **59177** 1.61 Kg.
- 2 **59178** 1.75 Kg.
- 2 **59179** 2.00 Kg.

3



### RUBBER - COLOR CODED

Color Coded Center

Embossed weight Color Coded Discus.

- 3 **59182** 0.750 kg. Yellow
- 3 **59184** 1.00 Kg. Blue
- 3 **59185** 1.25 Kg. Orange
- 3 **59186** 1.50 Kg. Green
- 3 **59187** 1.61 Kg.
- 3 **59188** 1.75 Kg.
- 3 **59189** 2.00 Kg.

4



### RUBBER - INDOOR

Solid Rubber, Accurate Weight in White Color (For Indoor use) Solid one piece construction.

- 4 **59221** 0.600 kg.
- 4 **59222** 0.750 kg.
- 4 **59224** 1.00 Kg.
- 4 **59226** 1.50 Kg.
- 4 **59227** 1.61 Kg.
- 4 **59228** 1.75 Kg.
- 4 **59229** 2.00 Kg.

### RUBBER - COLORED

For training, available in Red, Green, Yellow, Blue and Brown. (Please specify colors.)

- 5 **59211** 0.600 kg.
- 5 **59212** 0.750 kg.
- 5 **59214** 1.00 Kg.
- 5 **59215** 1.25 Kg.
- 5 **59216** 1.50 Kg.
- 5 **59217** 1.75 Kg.
- 5 **59219** 2.00 Kg.

5





## DISCUS HAND GRIP

Adjustable hand strap. Allow for efficient practice.

- 1 **59341** 1 kg.
- 1 **59342** 1.6 kg.
- 1 **59343** 2 kg.

1



## DISCUS CARRIER

Heavy duty vinyl, Holds two discuses or one discus and one Shot.

- 2 **59346** With Shoulder strap.
- 2 **59347** Without Shoulder strap.

Nylon Carry Bag.

- 3 **59351** For 1 kg.
- 3 **59352** For 2 kg.

## RUNNING SHOE SPIKES

Chrome Plated Spikes.

- 4 **59931 - 59935** Synthetic Spikes
- 5 **59941 - 59946** Pyramid Spikes
- 6 **59951 - 59956** Needle Spikes

## THROWING PUDS

These are mild steel throwing puds used to develop the throwing power, narrowing the gap between the throw and the weight.

- 7 **59596** 14L
- 7 **59597** 21L
- 7 **59598** 28L
- 7 **59599** 35L



2



3

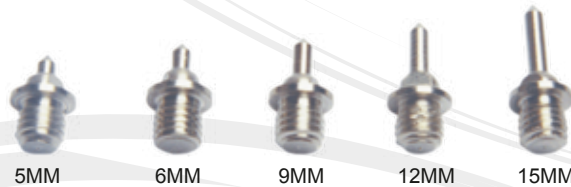

4



7



5



6





# Shots

# Track & Field



## GOLD 100-BRASS OLYMPIC

Olympic Shot has a small precisely machined to give a perfectly spherical shape.

- 1 **59401** 4.00 95 mm
- 1 **59403** 5.45 103 mm
- 1 **59405** 6.00 106 mm
- 1 **59406** 7.26 110 mm

## SUPER 200-ALLOY OLYMPIC

New Alloy Olympic Shot. Rust Proof. Stainless steel Lathe turned and precision balanced.

- 2 **59411** 4.00 100 mm
- 2 **59412** 4.00 95 mm
- 2 **59413** 5.45 103 mm
- 2 **59414** 6.00 107 mm
- 2 **59417** 7.26 110 mm
- 2 **59418** 7.26 115 mm
- 2 **59419** 7.26 129 mm

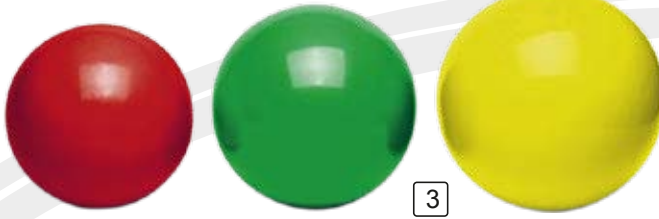

## SUPER 100-TURNED

High Competition Shots. Precision machine turned to different dia. Special polyurethane Paint coated for durable life.

- 3 **59422** 2.00 80 mm Blue
- 3 **59423** 2.50 88 mm Blue
- 3 **59424** 2.72 93 mm Blue
- 3 **59425** 3.00 97 mm Green
- 3 **59426** 3.25 100 mm Green
- 3 **59427** 3.63 100 mm Green
- 3 **59429** 4.00 100 mm White
- 3 **59430** 4.00 102 mm White
- 3 **59431** 4.00 104 mm White
- 3 **59432** 4.00 108 mm White
- 3 **59434** 5.00 114 mm Yellow
- 3 **59435** 5.45 115 mm Yellow
- 3 **59436** 6.00 119 mm Red
- 3 **59438** 7.26 120 mm Black
- 3 **59439** 7.26 125 mm Black
- 3 **59440** 7.26 128 mm Black

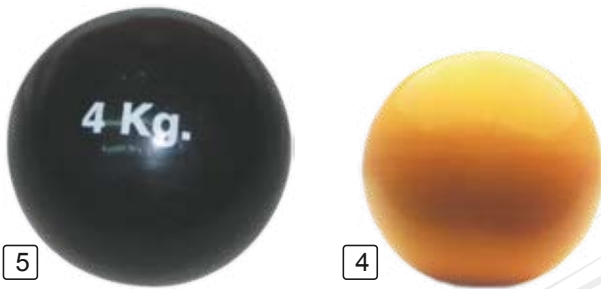

## SCHOOL-UNTURNE

Improved Iron Shots, Accurate weight. Painted in different colors.

- 4 **59449** 3Lbs. - Green
- 4 **59450** 4Lbs. 78 mm Blue
- 4 **59451** 1.00 63 mm Brown
- 4 **59452** 2.00 80 mm Blue
- 4 **59453** 2.50 88 mm Blue
- 4 **59454** 2.72 90 mm Blue
- 4 **59455** 3.00 94 mm Green
- 4 **59456** 3.25 95 mm Green
- 4 **59457** 3.63/8Lbs. 97mm Green
- 4 **59458** 4.00 100 mm White
- 4 **59459** 4.50/10Lbs. 103 mm White
- 4 **59460** 5.00 110 mm Yellow
- 4 **59461** 5.45/12Lbs. 115 mm Yellow
- 4 **59462** 6.00 118 mm Red
- 4 **59464** 7.26/16Lbs. 125 mm Black
- 4 **59465** 8.00 128 mm Maroon
- 4 **59467** 9.00/20Lbs. 130 mm Orange



## TRAINING-PRACTICE

Black Rough Shots. Tolerance more or less 100gms. for practice.

- 5 **59470** 2.00
- 5 **59471** 2.50
- 5 **59472** 2.72
- 5 **59473** 3.00
- 5 **59474** 3.25
- 5 **59475** 4.00
- 5 **59476** 5.00
- 5 **59477** 5.45
- 5 **59478** 6.00
- 5 **59479** 7.26



## SUPER-TURNED ECONOMY

Precision Turned economy shots meet IAAF Specifications. Turned out from Solid Cast Iron.

- 6 **59482** 2.00 Blue
- 6 **59484** 3.00 Green
- 6 **59485** 4.00 White
- 6 **59486** 5.00 Yellow
- 6 **59487** 5.45 Yellow
- 6 **59488** 6.00 Red
- 6 **59489** 7.26 Black

## INDOOR-RUBBER

A perfect shot, lead filled with plug. Does not damage Indoor surface. Matt finish to have perfect grip available in different colours.

- 7 **59490** 1.00 110 mm
- 7 **59491** 2.00 110 mm
- 7 **59492** 2.50 110 mm
- 7 **59493** 2.72 110 mm
- 7 **59494** 3.00 115 mm
- 7 **59495** 4.00 115 mm
- 7 **59496** 5.00 132 mm
- 7 **59497** 6.00 137 mm
- 7 **59498** 7.26 137 mm



### GOLD 100-BRASS OLYMPIC

Brass turned gauged with lead infill complete with steel ball bearing, wires & handle. Perfect center of gravity.

- 1 **59511** 4.00 95 mm
- 1 **59513** 5.45 102 mm
- 1 **59515** 6.00 107 mm
- 1 **59517** 7.26 110 mm

### SUPER 200-ALLOY OLYMPIC

Turned, Rust Proof stainless steel Hammer with steel Ball Bearing, wire & Handle. Perfect centre of gravity.

- 2 **59521** 4.00 95 mm
- 2 **59523** 5.45 103 mm
- 2 **59525** 6.00 110 mm
- 2 **59526** 7.26 110 mm

### SUPER 100-TURNED

Competition Hammer with steel Ball Bearing, wire & Handle. Perfect center of gravity.

- 3 **59530** 2.50 88 mm Blue
- 3 **59531** 3.00 97 mm Green
- 3 **59533** 4.00 102 mm White
- 3 **59534** 5.00 114 mm Yellow
- 3 **59536** 5.45 115 mm Yellow
- 3 **59537** 6.00 117 mm Green
- 3 **59538** 7.26 125 mm Black

### SCHOOL-UNTURNE

Improved practice cast iron Hammer. Complete with steel wire & Handle (#59580).

- 4 **59541** 2.50 Blue
- 4 **59542** 3.00 Green
- 4 **59544** 4.00 White
- 4 **59545** 5.00 Yellow
- 4 **59547** 6.00 Green
- 4 **59549** 8.00 Maroon
- 4 **59550** 8.50 Red

### HAMMER ACCESSORIES

3mm Hammer steel wire.

- 5 **59561** 780 mm
  - 5 **59563** 865 mm
  - 5 **59565** 960 mm
  - 5 **59567** 970 mm
  - 5 **59568** 980 mm
  - 5 **59570** 990 mm
  - 5 **59572** 1000 mm
- (Specific sizes are also available)

### HAMMER HANDLE

- 6 **59581** New IAAF handle, one piece construction aluminium.
- 7 **59580** Straight Model-entry level Hammer Handle Aluminium. High Breaking Strength.
- 8 **59577** Straight Model - Official
- 9 **59578** Curved Model

### HAMMER GLOVES

- 10 **59585** PROSOFT- Leather with buckle (LH/RH) Size -XXL/XL/L/M/S
- 10 **59586** SUPERPRO-Thick soft leather Velcro grip (LH/RH) Size XXL/XL/L/M/S

### THROWING WEIGHTS

Lathe turned iron weights with a special single piece constructed ball bearing Swivel and triangular Steel handle. Special Polyurethane paint coated for durable life.

- 11 **59555** 16Lbs. Yellow
- 11 **59556** 20Lbs. Red
- 11 **59557** 25Lbs. Blue
- 11 **59558** 35Lbs. Black
- 11 **59559** 56Lbs. Green

### CHAIN HAMMER

It is a unique hammer with galvanized chain. It is made to minimize the damage to the landing area.

- 12 **59591** 3
- 12 **59591** 4
- 12 **59591** 5
- 12 **59591** 6
- 12 **59591** 7.26



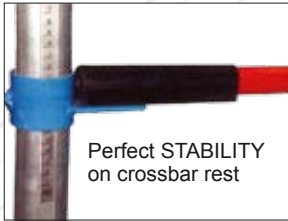

Perfect STABILITY on crossbar rest

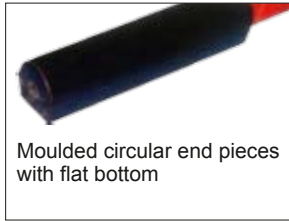

Moulded circular end pieces with flat bottom



### GISCO FIBER-GLASS CROSSBARS

Thick-walled. Pultruded fiberglass circular construction for minimum sag and maximum durability. Virtually unbreakable under normal conditions of use. Moulded half round plastic ends for the ultimate hold. High Visibility Orange with Black Stripes. IAAF certified.

- 1 **59961** High Jump Crossbar, Length 400cm
- 2 **59962** Pole Vault Crossbar, Length 450cm
- 3 **59963** Scholastic High Jump Crossbar, Length 400cm  
An Excellent choice for high School competition. High Visibility Orange with Black Stripes

Aluminum 30mm round with semi round plastic ends.

- 4 **59964** 4 meters

25mm aluminum 25mm with square plastic ends. One piece construction.

- 5 **59966** 4 meters

Made of elastic cord with 6" x 1" alternating Black & white foam sections.

- 6 **59870** Length: 15ft.

### WEIGHTED CROSS BAR

With durable weighted leather bags, sand filled.

- 7 **59872** Length: 15ft. PP rope.
- 8 **59873** Length: 15ft. elastic rope.



### ELASTIC CROSS BAR

High Tension Elastic rubber cord with 6" x 1" foam sections in Black & White alternative.

- 9 **59871** Length: 15ft.

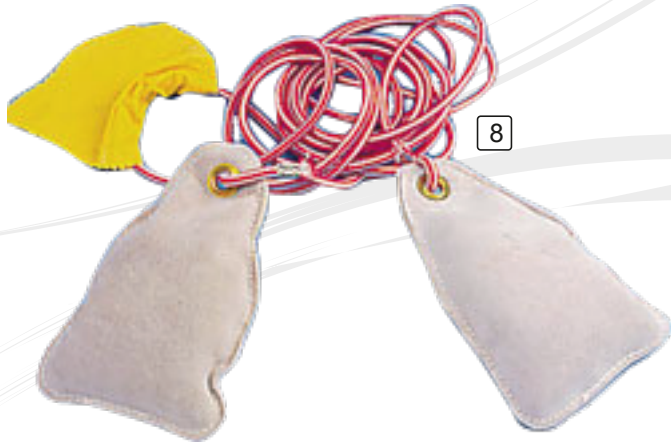



1



## RELAY BATONS-OFFICIAL

Senior

Aluminium anodized. Individually coloured 30 cms.

1 **59901** 38 mm dia (Set of 6)

1 **59902** 38 mm dia (Set of 8)

Official Plastic hollow, round ends. 30 cms. Senior.

2 **59904** 38 mm dia (Set of 6)

2 **59905** 38 mm dia (Set of 8)

2



## RELAY BATONS-JUNIOR

Aluminium anodized. Individually coloured, 30 cms.

3 **59911** 32 mm dia (Set of 6)

3 **59912** 32 mm dia (Set of 8)

Junior Plastic hollow, round ends 30 cms.

4 **59914** 32 mm dia (Set of 6)

4 **59915** 32 mm dia (Set of 8)



4



3

## HITTING AND THROWING BALL

Throwing ball made from leather, white, Ø 6.5 cm, non-bouncing.

5 **59792** 80g

## COMPETITION THROWING BALL

Made from leather Ø 7.6 cm, non-bouncing.

6 **59791** 200g

Made from rubber, Ø 7.6 cm, pink.

7 **59793** 200g

Made from porous rubber, Ø 6.5 cm, Yellow.

8 **59794** 80g

5



6



7



8



## PLYOMETRIC BOXES

Heavy duty mild steel, power coated frame. Laminated wood top covered with non-slip synthetic cloth.

9 **59751** 12"

9 **59752** 18"

9 **59753** 24"

9 **59754** 30"

9 **59755** 36"

## STARTER'S STAND

Powder coated for extra durability. Portable.

10 **59760**

10



9

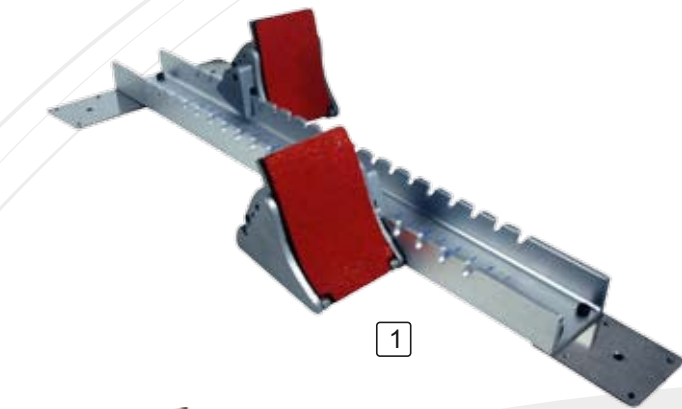

### OLYMPIC PRO

Olympic Pro 100mm heavy Aluminium slotted channel. Extra heavy aluminium foot blocks with 4 angle adjustable. Rust proof S/S plates with spike for synthetic track.

1 **59710**

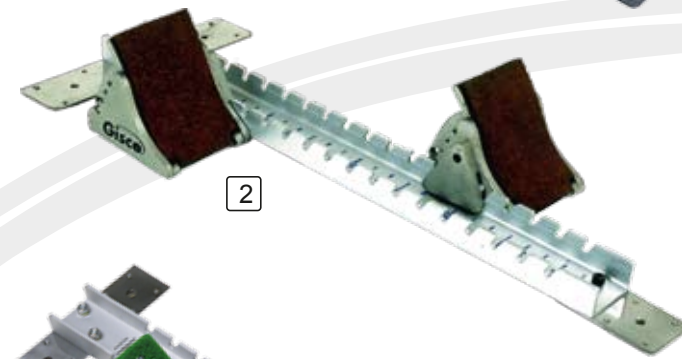

### INTERNATIONAL MODEL

75mm heavy Aluminium slotted channel. Heavy aluminium foot blocks with 4 angle adjustable. Rust proof S/S plates with spike for synthetic track.

2 **59711**

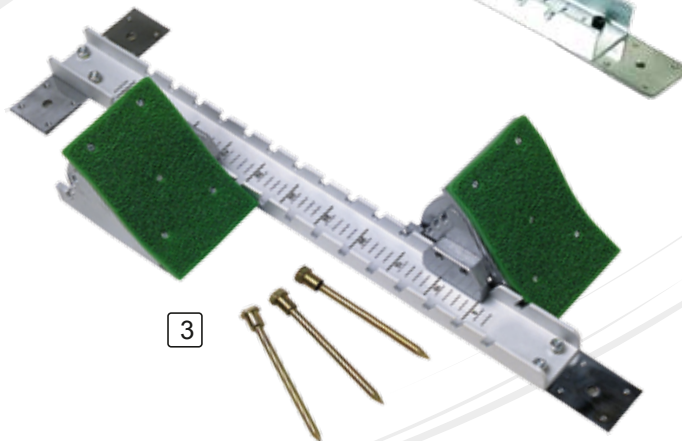

### COMPETITION STEEL MODEL

62mm slotted channel, rubber faced foot blocks adjustable to 4 different angles. Suitable for any track.

3 **59712**

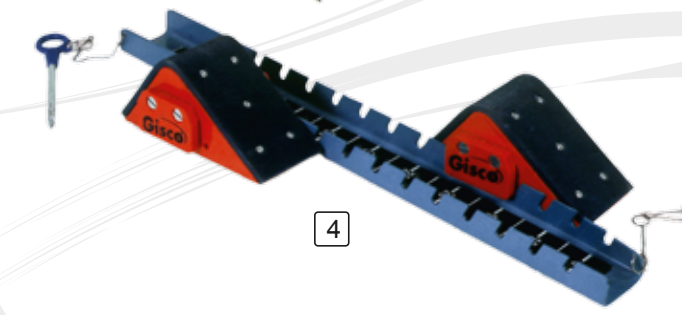

### CHALLENGER MODEL

Steel center rail is slotted for quick and easy movement of blocks. Artificial Rubber faced plastic foot blocks with rotating spikes for surfaces.

4 **59714**

Same as #59714 but with casted aluminium center rail, instead of steel.

4 **59715**

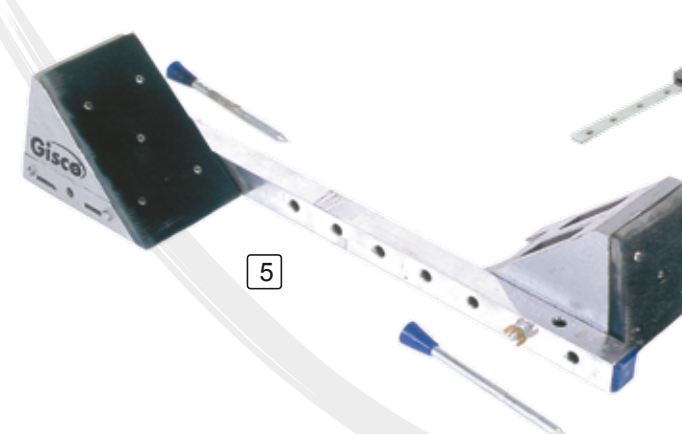

### SIMPLEX MODEL

Aluminium bar fitted with rubber faced blocks to take in spikes. Rotating spikes for artificial surfaces.

5 **59725**

Same as model #59705 but without rubber faced and rotating spikes for grass and cinder surface.

5 **59726**



### STANDARD BLOCK

Solid casted alum center bar with tartan rubber faced alum foot block

6 **59732**

Solid casted alum center bar with tartan rubber faced alum foot block with S/S plated spike at both ends for synthetic tracks.

6 **59733**



### CHAMPIONSHIP MODEL

Adjustable 32" double bar, rubber faced foot blocks with large end small pins suitable for all tracks

1 **59737**

### RECORD MASTER

A durable, rubber faced starting block with anchor spikes for dirt tracks.

2 **59738**

### INDOOR/OUTDOOR BLOCK

Moulded rubber shaped blocks. Foot pressure on the flaps provides a non slip start

3 **59740**

### JAVELIN-PRACTICE

Aluminum alloy with cord grip. No guarantee against bending & breakage.

- 4 **59851** 800 gms Blue
- 4 **59852** 700 gms Green
- 4 **59853** 600 gms Orange
- 4 **59854** 500 gms Yellow
- 4 **59855** 400 gms Red

### JAVELIN PRACTICE BALL

Practice Ball Rubber, filled with lead/steel Balls.

- 5 **59856** 400 gms. 68 mm
- 5 **59857** 600 gms. 68 mm
- 5 **59858** 800 gms. 68 mm

### NOCKEN BALLS

Javelin Training, designed to give the feeling of javelin

- 6 **59861** 400 gms. Red
- 6 **59862** 600 gms. Green
- 6 **59863** 800 gms. Blue
- 6 **59864** 1 Kg. Yellow

### LANE MARKERS

Stable & Weather Proof. Moulded Fibreglass, Innovative design

- 7 **59981**
- 8 **59982** 41 cm Height.
- 9 **59983** 31 cm Height.

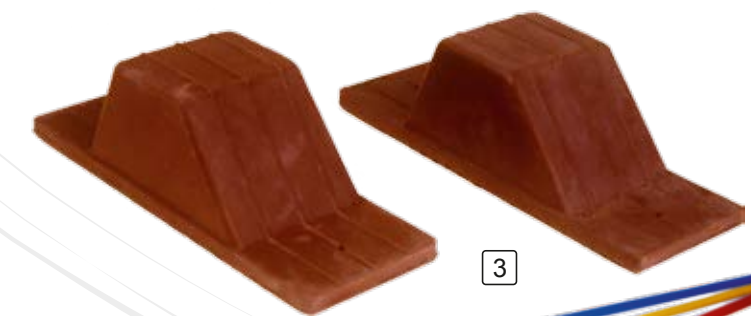
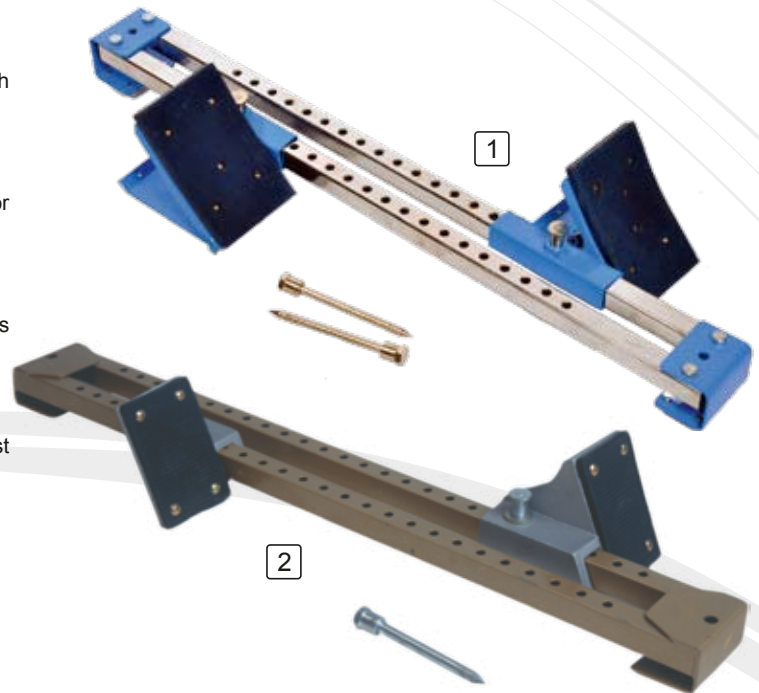



1

### STEELABS CASE

Sturdy ABS Case.  
Heavy duty chrome plated winding mechanism.  
Width 13mm.

- 1 **59661** 20m
- 1 **59662** 30m
- 1 **59663** 50m



2

### STEEL OPEN REEL TAPES (PAINTED BLADE)

Metal open reel case 13mm width. Rubberised non-slip grip for comfortable handling

- 2 **59666** 10m/33ft
- 2 **59667** 15m/50ft
- 2 **59668** 20m/66ft
- 2 **59669** 30m/100ft

### STEEL OPEN REELABS CASE

ABS open reel case. Long winding arm for quick rewinding. Protruding marker at the bottom of case.

- 3 **59671** 50m
- 3 **59672** 100m



3



4

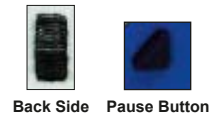

### MAX

ABS case with side pause button. Width 16mm.

- 4 **59685** 2m
- 4 **59686** 3m
- 4 **59687** 5m



**MEASURES FORWARD & BACKWARDS**  
Subtracts when retracting steps



**FIVE DIGIT COUNTER**  
Mechanical 10,000 M counter with quick reset lever. Minimum reading 10 cm.

**PLASTIC WHEEL**  
ABS plastic wheel is extremely light weight and durable. Two Section telescopic handle.

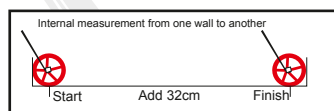
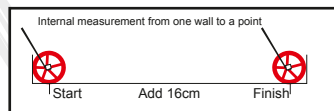

6

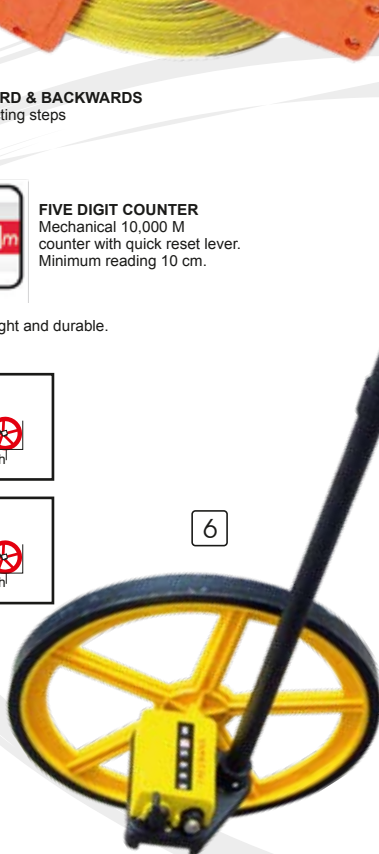

5



### PROLOK

Compact contour design case with rubberised grip. Click action lock is ideally positioned for locking with thumb. Retractable cushion to protect the end hook. Hand strap (optional) for easy carrying, without obstructing inside measurement. Width 13mm

- 5 **59681** 3m
- 5 **59682** 5m

### MEASURING WHEEL

- 6 **59651** Offer quick and easy solution for long distance measuring requirements.  
Circumference : 1m  
Accuracy: Conforming to class 10 IML Standards.



1

### FIBER GLASS OPEN REEL

Design allows easy cleaning of tape. Long winder with easy grip knob facilities quick rewinding. Heavy duty ABS case. Protruding marker at the bottom of the case allows easy measurement of land. Bold numbers for easier reading. Width 13mm.

- 1 **59612** 30m/100ft
- 1 **59614** 50/164ft
- 1 **59615** 100m/328ft

### NON CONDUCTIVE

Ideal suited for use where electrical hazards exist. Being non conductive, it can be used safely when dry on electrical work.

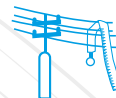

### WATER PROOF

The figures, lines and the plastic coating remain unaffected by water.



### EASY TO CLEAN

A damp cloth is all that is necessary to remove dirt, mud and other stains.



### WEAR RESISTANT

Ideal for field work where rough conditions prevail.



### NON CREASING

The plastic coating makes the tape resistant to crumpung, creasing or twisting.



2

### TOP GEAR OPEN REAL

3 times faster, quick wind geared system sturdy extram long winding arm. Soft feel handle for comfort and non-slip grip. Protruding marker at the bottom of case. 1 mm marking with class II accuracy ribbon optional. Width 13mm

- 2 **59617** 30m/100ft
- 2 **59618** 40m/132ft
- 2 **59619** 50/164ft
- 2 **59620** 60m/200ft

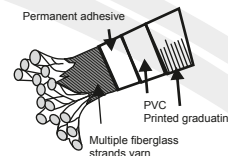

### FIBER GLASS TAPES

The tough leath erette covered steel case makes it resistant chemical corrosion and breakage even on rough handling. Durable winding mechanism ensures long life, trouble free usage and is designed to give accurate measurement. Width 13mm

- 3 **59631** 15m/50ft
- 3 **59632** 20m/66ft
- 3 **59634** 30m/100ft
- 3 **59635** 50/164ft



4

### FIBER GLASS TAPES

Heavy duty winding mechanism. Tough yet lightweight ABS case. Bold numbers for easier reading. Width 13mm.

- 4 **59621** 10m/33ft
- 4 **59622** 15m/50ft
- 4 **59624** 20m/66ft
- 4 **59625** 30/100ft
- 4 **59626** 50m/164ft

3







### FIELD MARKER FLAGS

Field marker with assorted color flags.  
1 **59931** 42 cms gal studs



### DISTANCE MARKER RECTANGULAR

42 cms galvanized stud with Metal Plate.  
2 **59933** 1 to 10  
2 **59934** 1 to 15  
2 **59935** 1 to 20



### DISTANCE MARKER- SQUARE

Metal Plate (140 mm x 115 mm) with Strong Stud (28cms).  
3 **59938** 1 to 10  
3 **59939** 1 to 15



### DISTANCE MARKER-ROUND

Numbered round metal Plate with stud.  
4 **59941** 1 to 10  
4 **59942** 1 to 15  
Strong steel, 3" round black writing surface to provide ample room to write names numbers.  
5 Jet Black



### SHOT TOE BOARD- ALUMINIUM

Aluminium casted, toughest toe boards as per IAAF standards.  
6 **59951** 4" High x 4 1/2" wide.  
6 **59952** 3 1/2" High x 4 1/2" wide.



### SHOT TOE BOARD- METAL

All metal radiating lines speedup accurate measurement  
7 **59955** 4" High x 4 1/2" wide.



### OFFICIAL FLAGS

New Unbreakable Plastic dowel. Official flag stick.  
8 **59956** Yellow  
8 **59957** White  
8 **59958** Red



### LAP BELL

9 **59761** Brass lap bell

### RUN UP MARKER

Made of two metal round sheet welded & powder coated in six bright colours for easy location.  
10 **59762**

### STARTER CLAPPER

Best sound with dual color for visual starting signal.  
11 **59760**

### LAP COUNTER

12 **59760**





1

## MAGNETIC TACTIC BOARD

Erasable, with magnetic dots, Pen & back support.

1 **86001** Size: 90 x 60cm.

2 **86002** Size: 60 x 45cm.

3 **86003** Size: 45 x 30cm.

Specific design available on request.

Sports :

- Soccer
- Basket Ball
- Handball
- Hockey
- Rugby

2



3



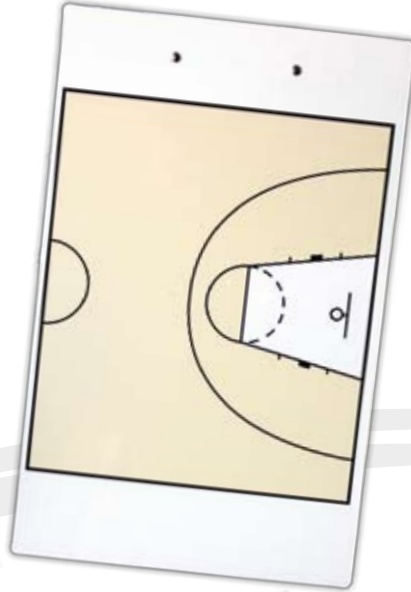
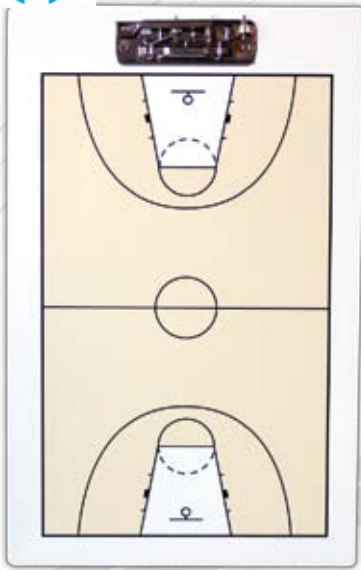

1

### COACH BOARD "TRAINER"

Board for all major Sports, must for coaches, instructors.  
2-sided Flex board – Full field on one side  
Close-up of half field on the other side  
Durable clip to hold paperwork  
Realistic full color  
Write-on/wipe-off  
Includes special board marker  
Size:— 25.5 cm x 41.75 cm (10" x 16")

Specific design available on request.

1 **86005** Basket Ball

2 **86006** Soccer

3 **86007** Volley Ball

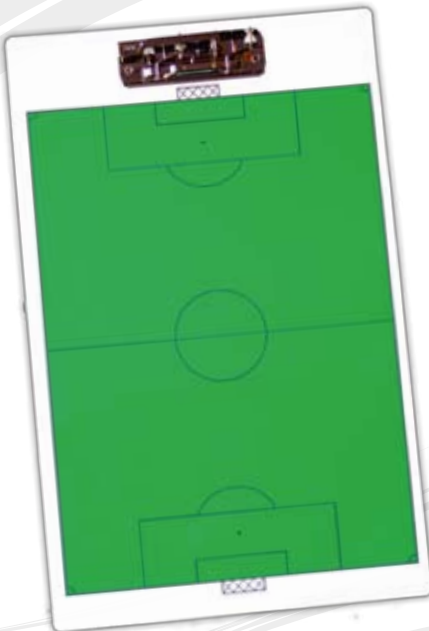

2

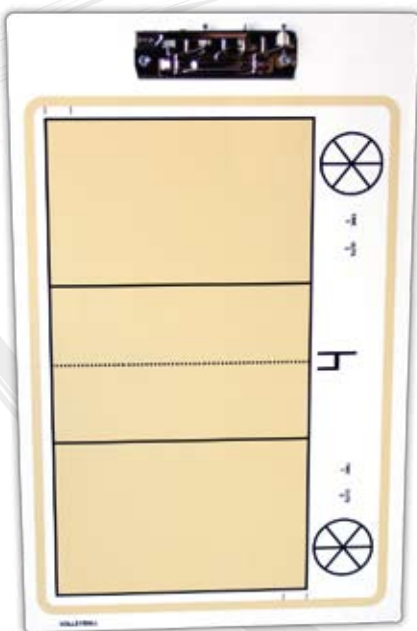

3



1



2

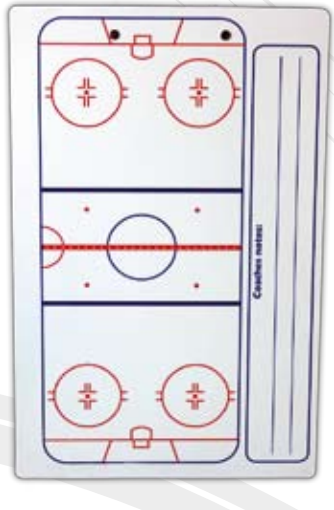
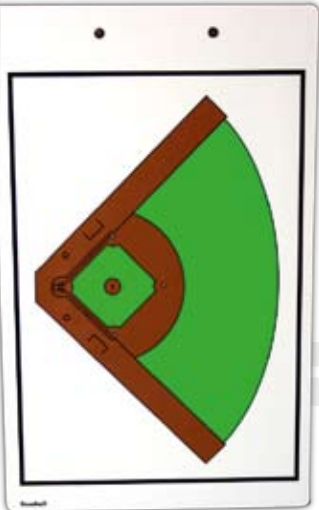

### COACH BOARD "TRAINER"

Board for all major Sports, must for coaches, instructors.  
 2-sided Flex board – Full field on one side  
 Close-up of half field on the other side  
 Durable clip to hold paperwork  
 Realistic full color  
 Write-on/wipe-off  
 Includes special board marker  
 Size:— 25.5 cm x 41.75 cm (10" x 16")

Specific design available on request.

- 1 **86008** Base Ball
- 2 **86009** Hockey
- 3 **86010** Hand Ball

### COACH BOARD "PROFESSIONAL"

Board for all major Sports, must for coaches, instructors.  
 2-sided Flex board – Full field on one side  
 Close-up of half field on the other side  
 Realistic full color  
 Write-on/wipe-off

Includes one Pro pocket board  
 Includes special board marker  
 Size:— 28 cm x 38 cm (11" x 15")

- 4 **86015** Soccer

3

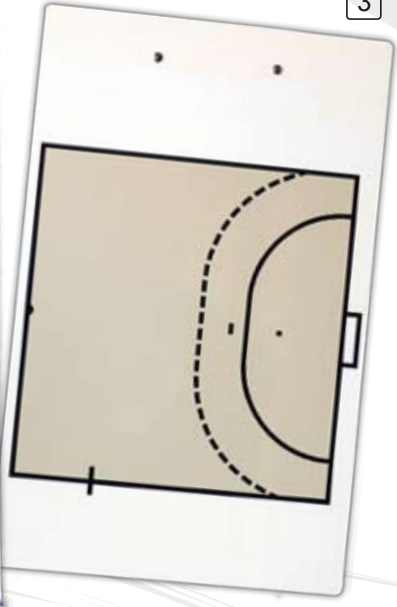
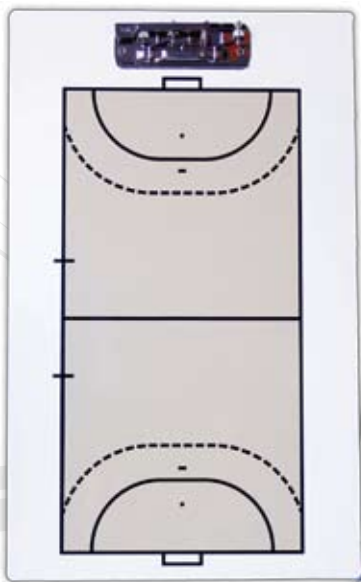

4





1

### MEDICINE BALL RUBBER

Unique and versatile total body training tool that help develop muscular strength, endurance, power, stability and joint integrity. The color-coded medicine balls will bounce and maintain its shape, and it is extremely durable.

- 1 **50051** 1 Kg. ● Yellow 195 mm
- 1 **50052** 1.5 Kg. ● Orange 195 mm
- 1 **50053** 2 Kg. ● Green 195 mm
- 1 **50055** 3 Kg. ● Blue 230 mm
- 1 **50056** 4 Kg. ● Red 230 mm
- 1 **50057** 5 Kg. ● Purple 275 mm
- 1 **50058** 6 Kg. ● BLACK 275 mm

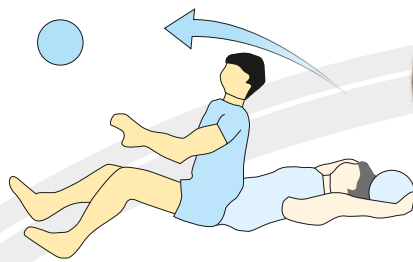

3



2

### MEDICINE BALL LEATHER

Natural genuine leather ball with firm filling, 10 Panels.

- 2 **50061** 1 Kg. 180 mm
- 2 **50062** 2 Kg. 195 mm
- 2 **50063** 3 Kg. 210 mm
- 2 **50064** 4 Kg. 225 mm
- 2 **50065** 5 Kg. 245 mm

### MEDICINE BALLS LEATHER - ECONOMY

2 Panels. Economy model introduced. Real leather. Tan color.

- 3 **50111** 1 Kg.
- 3 **50112** 2 Kg.
- 3 **50113** 3 Kg.
- 3 **50114** 4 Kg.
- 3 **50115** 5 Kg.



4

### MEDICINE BALLS-RED & BLACK

Genuine Leather, Red & Black. Painted. 10 Panels.

- 4 **50071** 1 Kg. 180 mm
- 4 **50072** 2 Kg. 195 mm
- 4 **50073** 3 Kg. 210 mm
- 4 **50074** 4 Kg. 225 mm
- 4 **50075** 5 Kg. 245 mm

### MEDICINE BALLS SYNTHETIC

Synthetic waterproof, Red & Black. 10 Panels.

- 5 **50081** 1 Kg. 180 mm
- 5 **50082** 2 Kg. 195 mm
- 5 **50083** 3 Kg. 210 mm
- 5 **50084** 4 Kg. 225 mm
- 5 **50085** 5 Kg. 245 mm



5

### WEIGHT LIFTING GLOVES

- 6 **50141** Soft Chrome Leather With Velcro.
- 7 **50142** Leather Palm, Mesh Back With Velcro.



6

### WEIGHT LIFTING BELTS

Natural genuine leather With Padding

- 8 **50121** SMALL
- 8 **50122** MEDIUM
- 8 **50123** LARGE
- 8 **50124** XLARGE

Black Genuine Leather With Padding

- 8 **50131** SMALL
- 8 **50132** MEDIUM
- 8 **50133** LARGE
- 8 **50134** XLARGE



7

### WEIGHT LIFTING BELTS-EVA

Eva foam Padding with velcro adjustment.

- 9 **55136** Small
- 9 **55137** Medium
- 9 **55138** Large
- 9 **55139** X Large



9



8

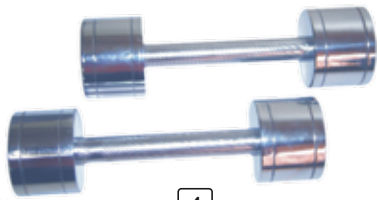

4

### EXERCISE MATS

Strong Cover Multi Purpose Exercise Mats.  
Straight Model

1 **50661** 180 cm x 60 cm x 20mm

Foldable Model

2 **50662** 180 cm x 60 cm x 15 mm

Soft vinyl aerobic mat for extra comfort and maximum versatility, 10 mm thick foam. Instructions for exercising are printed on the mat. can be easily cleaned with a damp cloth.

3 **50663** size : 2' x 6'



2



1

### DUMBBELL STEEL

Steel Chrome Plated dumbbells.

4 **50481** 1 Kg.

4 **50482** 1.5 Kg.

4 **50483** 2 Kg.

4 **50484** 2.50 Kg.

4 **50485** 3 Kg.

4 **50486** 4 Kg.

4 **50487** 5 Kg.

4 **50488** 10 Kg.

3



### WEIGHT VEST

Heavy duty nylon material features pockets for weight increment through secured weight pockets. foam padding on the shoulder. Velcro closer belt. Safe and balance distribution of the weight.

Variable individual weight for maximum comfort and flexibility. use for your aerobic conditioning, strength training, weight loss, sports specific training, walking etc.

5 **50551** 10L S 20 pockets 400g

5 **50552** 20L M 20 pockets 400g

### KETTLE BELLS- SOLID BLACK

6 **50501** 4 Kg. 90 mm

6 **50502** 8 Kg. 113 mm

6 **50503** 10 Kg. 120 mm

6 **50504** 12 Kg. 130 mm

6 **50505** 16 Kg. 150 mm

6 **50506** 20 Kg. 165 mm

6 **50507** 24 Kg. 172 mm

5



7



6

### SLING BALL

Natural genuine leather, hand stitched. Pigmented.

7 **50091** 1Kg.

7 **50092** 2Kg.

7 **50093** 3Kg.

### BALANCE BOARD

Heavy duty Construction, Ideal for sports training & rehabilitation

8 **50149**



8

### WRIST/ANKLE WEIGHTS

Nylon weighted Pouches filled with Velcro Straps for easy fastening. Sold in pair.

9 **50471** 2 x 500g

9 **50472** 2 x 750g

9 **50473** 2 x 1125g

9 **50474** 2 x 2250g



9



10

### POWER GRIP

10 **50146** With Hand Impression Grip



# Skipping Ropes

# Fitness



### EXOTIC WOOD SPEED ROPES

Made of engineered, densified, compressed wood with satin smooth finish. Replica of conventional short handle speed rope. Fully adjustable with 5mm. Metallic cord and can withstand minus temperatures. Perfect for all level of jumping and a nice cross trainer. Available in 7', 8', 9' & 10'.

- 1 **50606-7** 2.14M (7ft)
  - 1 **50606-8** 2.43M (8ft)
  - 1 **50606-9** 2.74M (9ft)
  - 1 **50606-10** 3.05M (10ft) & Custom lengths.
- Color: Black Metallic, Blue Metallic, Cherry Metallic  
Handle: Naturally Polished Seasoned Exotic Wood Speed Handles

### BEACH WOOD SPEED ROPES

Naturally Polished Seasoned Beech Wood

- 2 **50607-7** 2.14M (7ft)
  - 2 **50607-8** 2.43M (8ft)
  - 2 **50607-9** 2.74M (9ft)
  - 2 **50607-10** 3.05M (10ft) & Custom lengths.
- Color: Black Metallic, Blue Metallic, Cherry Metallic



### KIDS SPECIAL TRI COLOR SPEED ROPE

5" long ergonomically designed plastic handle. Glossy finish handle is perfect for free spinning. Tangle free TRI color rope with fine combination of stiffness and flexibility makes it a perfect speed rope. Fully Adjustable.

- 3 **50604-7** 2.14M (7ft)
  - 3 **50604-8** 2.43M (8ft)
  - 3 **50604-9** 2.74M (9ft)
  - 3 **50604-10** 3.05M (10ft) & Custom lengths.
- Handle Color : Blue, Black, White & Cherry

### BEADED JUMP ROPES

- 4 **50608-7** 2.14M (7ft)
  - 4 **50608-8** 2.43M (8ft)
  - 4 **50608-9** 2.74M (9ft)
  - 4 **50608-10** 3.05M (10ft) & Custom lengths.
- Bead Colour: Red, Blue, Black, White, Purple, Green, Yellow.  
Bead Size: 1" (one inch)



### CLOTH JUMP ROPES

Polypropylene ropes - very soft on your hands are easy to control and will not bounce when they hit the floor - a great advantage in training and competition. Easiest to cope and holds a good arc. No handles.

- 5 **50609** 3.05m (10ft)



### LICORICE SPEED ROPES

The modern way of rope skipping. Ideal for speed skipping. 5mm. Solid Poly vinyl ropes with durable easy grip black handles for fast spinning, twin color rope.

Colour: ●●●●●●●●

- 1 50601-7 2.14M (7ft)
- 1 50601-8 2.43M (8ft)
- 1 50601-9 2.74M (9ft)
- 1 50601-10 3.05M (10ft)

### TWIN COLOR ROPES

- 2 50601-7 T 2.14M
- 2 50601-8 T 2.43M
- 2 50601-9 T 2.74M
- 2 50601-10 T 3.05M

### DOUBLE-DUTCH LICORICE SPEED ROPES

Fun and fast game in bright colours with Black handle.

Length:

- 3 50602-14 4.25M (14ft)
- 3 50602-16 4.90M (16ft)
- 3 50602-20 6.00M (20ft)
- 3 50602-22 6.70M (22ft) & Custom lengths.

Colour: ●●●●●●●●

Rope Diameter: 6mm

### JUMP ROPES

Hollow Poly vinyl ropes with durable handles for fast spinning.

- 4 50603-7 2.14M (7ft)
- 4 50603-8 2.43M (8ft)
- 4 50603-9 2.74M (9ft)
- 4 50603-10 3.05M (10ft) & Custom lengths.

Colour: ●●●●●●●●

Rope Diameter: 6mm

### DOUBLE-DUTCH LICORICE JUMP ROPES

Hollow Poly vinyl ropes with durable Black handles.

Length:

- 5 50605-14 4.25M (14ft)
- 5 50605-16 4.90M (16ft)
- 5 50605-20 6.00M (20ft)
- 5 50605-22 6.70M (22ft)

Colour: ●●●●●●●●

Rope Diameter: 6mm







1



2



3

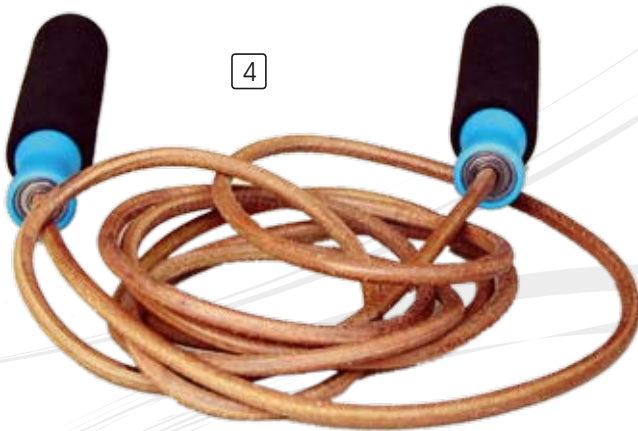

4

### POLYPROPYLENE WOODEN SKIPPING ROPES

- 1 **50657-7** 2.14M (7ft)
- 1 **50657-8** 2.43M (8ft)
- 1 **50657-9** 2.74M (9ft)
- 1 **50657-10** 3.05M (10ft)

White Polypropylene 8mm rope.  
Naturally polished wooden handles.

### COTTON SKIPPING ROPES

- 2 **50658-7** 2.14M (7ft)
- 2 **50658-8** 2.43M (8ft)
- 2 **50658-9** 2.74M (9ft)
- 2 **50658-10** 3.05M (10ft)

Biodegradable Cotton Rope 7mm  
Naturally polished hollow wooden handles.

### FOAM BALL BEARING SKIPPING ROPES

- 3 **50659-8** 2.43M (8ft)
- 3 **50659-9** 2.74M (9ft)
- 3 **50659-10** 3.05M (10ft)

Red & Blue Translucent 6 mm PVC cord.  
Neoprene foam grips with molded ball bearings handles in Red & Blue color

### FOAM BALL BEARING LEATHER SKIPPING ROPES

- 4 **50656-8** 2.43M (8ft)
- 4 **50656-9** 2.74M (9ft)
- 4 **50656-10** 3.05M (10ft)

Natural Leather 6mm.  
Neoprene foam grips with molded ball bearings handles in Red & Blue colour

### To find Right Rope length

Determining the exact length of a rope for an individual, stand in the middle of the cord and handles up, the handle tips should reach your armpits. When you jump over the rope, the rope should just brush the floor beneath your feet. If the cord doesn't touch the floor, the rope is too short. If the cord hits the floor in front of your feet, the rope is too long and should be shortened. The proper rope length is determined by your body height:

#### Length

- 2.14M (7 ft)
- 2.43M (8 ft)
- 2.73M (9 ft)
- 3.05M (10 ft)
- 14 ft & over

#### Suitable for the Body height

- up to 4'8" (1.40m)
- 4'9" - 5'3" (1.60m)
- 5'4" - 5'9" (1.75m)
- 5'11" - 6'5" (1.95m)
- Double Dutch Jumping



1



2



3



4



5

### BOXERS THAI STYLE BALL BEARING SKIPPING ROPES

Injection Moulded, Ball Bearings fitted Blue Handles  
Blue Translucent PVC 10mm. cord.

- 1 **50611-8** 2.43M (8ft)
- 1 **50611-9** 2.74M (9ft)
- 1 **50611-10** 3.05M (10ft)

### BOXERS THAI STYLE SKIPPING ROPES

Naturally Polished Seasoned Rubber Wood Handles  
Heavy Duty Walnut Colour Vinyl Tube

- 2 **50654-8** 2.43M (8ft)
  - 2 **50654-9** 2.74M (9ft)
  - 2 **50654-10** 3.05M (10ft)
- Diameter: 12mm

### LEATHER BALL BEARING SKIPPING ROPES

Natural Leather 6mm Naturally polished wooden handles.

- 3 **50651-8** 2.43M (8ft)
- 3 **50651-9** 2.74M (9ft)
- 3 **50651-10** 3.05M (10ft)

### POLYPROPYLENE BALL BEARING SKIPPING ROPES

White Polypropylene 7 mm rope with naturally polished wooden handles.

- 4 **50652-8** 2.43M (8ft)
- 4 **50652-9** 2.74M (9ft)
- 4 **50652-10** 3.05M (10ft)

### SPARKLE SKIPPING ROPES

Biodegradable PP Rope 7mm  
Wooden Sparkle Handles fitted with Nickel Plated Metal Caps and side springs.

- 5 **50615-7** 2.14M (7ft)
- 5 **50615-8** 2.43M (8ft)
- 5 **50615-9** 2.74M (9ft)
- 5 **50615-10** 3.05M (10ft)



1

### MULTI CRICKET TRAINING

Simplified game of Cricket for boys and girls of all ages. Can be played all year on any surface. Double set contains two bats, two balls, two stump bases, four bails and 6 stumps with nylon carry bag.

- 1 **54121** Adult Set (32 $\frac{3}{4}$ " Bat)
  - 1 **54122** Senior Set (30 $\frac{1}{2}$ " Bat)
  - 1 **54123** Junior Set (29" Bat)
- Single set contains 1 bat, 1ball, 1 stump base, 2 bails and 3 stumps in nylon bag.
- 1 **54127** Adult Set (32 $\frac{3}{4}$ " Bat)
  - 1 **54128** Senior Set (30 $\frac{1}{2}$ " Bat)
  - 1 **54129** Junior Set (29" Bat)
- Individual .
- 1 **54131** Senior Bats 30 $\frac{1}{2}$ "
  - 1 **54132** Junior Bats 29"
  - 1 **54133** Balls
  - 1 **54135** Stump
  - 1 **54136** Stump Base
  - 1 **54139** 1 Bat (30 $\frac{1}{2}$ ") + Ball
  - 1 **54140** 1 Bat (29") + 1 Ball

### INNER BOUNDARY MARKERS

- 2 **54144** White 7 $\frac{1}{2}$ " Dia Plastic Disc

### BOWLERS MARKER DISC

- 3 **54145** White 2 $\frac{1}{2}$ " Dia  $\frac{1}{2}$ "  $\frac{1}{2}$ "

### CRICKET BOUNDARY FLAG

Easy to mark boundaries.

- 4 **76011** Pack of 20. White.

### BOUNDARY MARKED CONES

White marker cones for setting boundaries.

- 5 **76014** Set of 20 Loitn cary derice.

### WICKET GAUGES

Ideal measuring tool for exact position of stumps.

- 6 **76015** Metal gauge



2



3

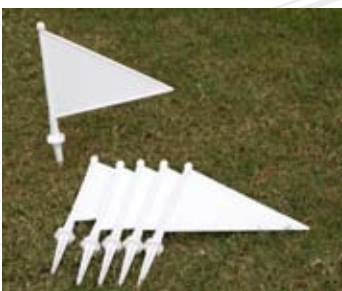

4



5



5



### CRICKET REBOUNDER

Entry Level Training rebounder, red frame.

1 **76250** 1000 x 1000mm.

Effective ball return training rebounder.

2 **76251** 800 x 800mm.

2 **76252** 1000 x 1000mm.

### POP-UP CRICKET

Ideal Training goal for cricket training.

3 **76301** 180 x 100 x 100cm.

### THROWING STUMP

Single stump fixed to spring spike.

4 **76101** Wooden.

### FREE STANDING STUMP

Durable practice stumps used for indoor/outdoor.

5 **76104** 28" high.

### SPRING RETURN STUMP

Metal base with 3 stumps & balls.

6 **76105** 272 mm (30 inch).

1



2



4



5



6

3





1



**CRICKET NET CAGE**

9 Ft. High / 10 Ft. wide, Heavy duty coated steel cage.

Complete with steel pegs, wire & U-pegs.

1 **76201** Suitable for 6m long cage.

1 **76202** Suitable for 10m long cage.

**PEG ANCHOR**

2 **66479** SHORT Model.



2

# Training Vests

## Vests



### BRIGHT MESH VEST

Bright mesh stretchable polyester, self-trimming, pleasant touch, one of the best quality.

1



*Bright Mesh*

1	53201	Adult
1	53202	Junior
1	53203	Kids

Colors:

- Red
- Yellow
- Neon yellow
- Neon orange
- Green
- Neon Green
- Neon pink
- Royal Blue
- Black
- White.

### REVERSIBLE

2	53206	Adult
2	53207	Junior
2	53208	Kids

2



*Bright Mesh*

Colors :

- White/Black
- Red/Blue
- Yel/Red
- Red/Green

### FINE MESH TRAINING VEST – Black trim

90gsm fine mesh polyester fabric.

3



*Fine Mesh*

3	53211	MENS
3	53212	YOUTHS
3	53213	BOYS

Colors:

- Red
- Neon Yellow
- Black
- Neon orange
- Blue
- Neon Green
- Purple
- White
- Pink
- Sky blue.

### FINE MESH TRAINING VEST – Self trim

90 gsm fine mesh polyester soft fabric. Most Sellable Broader arms with self trim.

4



*Fine Mesh*

Colors:

- Red
- Neon Yellow
- Black
- Neon orange
- Blue
- Neon Green
- Purple
- White
- Pink
- Sky blue.

4	53124	T0 XSmall	L 44 cm	50 cm H
4	53123	T1 Small	L 50 cm	60 cm H
4	53122	T2 Large	L 54 cm	68 cm H
4	53121	T3 XXLarge	L 60 cm	73 cm H

### NUMBERED BIBS

Smaller number on front, bigger on the back. 1-15.

2



*Fine Mesh*

Color:

- Neon Yellow
- Neon Orange

5	53214	T1 Small	L 50 cm	60 cm H
5	53215	T2 Large	L 54 cm	68 cm H
5	53216	T3 XXLarge	L 60 cm	73 cm H

### FINE MESH TRAINING VEST – Free strip

With a free strip for the sponsor on the front.

6



*Fine Mesh*

6	53141	Senior
6	53142	Junior
6	53143	Kids



## PRO LEVEL BIB

100% polyester micro mesh to give light feels and breathable performance.



- Colors:
- Red
  - Neon yellow
  - Neon orange
  - Blue
  - Green
  - Neon Green
  - Pink
  - Blue

1	53161	Senior
1	53162	Small mens
1	53163	Junior

# Vests Training Vests

## BRIGHT LINING TRAINING VEST

Bright lining 100% polyester fabric, self-trimming, pleasant touch.



2	53224	Small
2	53225	Medium
2	53226	XLarge

## PRO TRAINING VESTS

Combination of mesh / plain lining polyester material. Lightweight and breathable Black trim.

3	53231	Mini
3	53232	Junior
3	53233	Senior



## COTTON TRAINING bibs

Heavy duty cotton drill. Fastened elastic one side, velcro one side



- Colors:
- Yellow
  - Royal Blue
  - Sky Blue
  - Red
  - Green
  - Orange
  - Black

4	53331	30cm x 35cm	Small
4	53332	36cm x 48cm	Medium
4	53333	40cm x 54cm	Large
4	53334	43cm x 57cm	Extra Large

## Numbered Cotton bibs

Heavy duty cotton drill. Fastened elastic one side, velcro one side.

Numbered 1-10 on both sides.

5	53336	36cm x 48cm	Medium
5	53337	40cm x 54cm	Large



## Cotton Netball bibs

Heavy duty cotton drill. Fastened elastic one side, velcro on the other. Set of 7 letters on both sides.

6	53343	36cm x 48cm	Medium
6	53344	40cm x 54cm	Large

# Training Vests

## Vests



### NYLON TRAINING bibs

Heavy duty nylon. Fastened elastic one side, velcro on the other.

Available in 12 colors:

- ○ Yellow, Neon Yellow
- ○ Orange, Neon Orange
- ● Red, Royal blue
- ● Sky blue, Green
- ● Purple, Pink
- ● White, Black.

2	53301	30cm x 35cm	Small
2	53302	36cm x 48cm	Medium
2	53303	40cm x 54cm	Large
2	53304	43cm x 57cm	Extra Large

### NYLON TRAINING BIB – Hi viz

Heavy duty nylon with black trimming. Fastened elastic one side in middle, velcro on the other.

Available in 9 colors:

- ● Yellow, Neon Orange,
- ● Red, Royal blue,
- ● Sky blue, Green,
- ● Purple, Pink

3	53355	36cm x 48cm	Medium
3	53356	40cm x 54cm	Large
3	53357	43cm x 57cm	Extra Large

### REVERSIBLE NETBALL BIBS

Heavy duty cotton drill. Fastened elastic one side, velcro on the other. Set of 7 letters on both sides.

Available in 5 colour combinations:

- Amber / Black
- Emerald / Black
- Red / Black
- Red / Navy
- Sky / Navy

1	53345	36cm x 48cm	Medium
1	53346	40cm x 54cm	Large

### Numbered Nylon Bibs

Heavy duty nylon. Fastened elastic one side, velcro on the other. Set of 10. Numbered 1-10 on both sides.

3	53306	36cm x 48cm	Medium
3	53307	40cm x 54cm	Large

### Nylon Netball bibs

Heavy duty nylon. Fastened elastic one side, velcro on the other. Set of 7 letters on both sides.

5	53313	36cm x 48cm	Medium
5	53314	40cm x 54cm	Large

### Numbered Nylon Basketball bibs

Heavy duty nylon. Fastened elastic one side, velcro on the other. Set of 12. Numbered 4-15 on both sides.

4	53309	36cm x 48cm	Medium
4	53310	40cm x 54cm	Large





# Bibs

# Training Vests

## Nylon Hockey bibs

Heavy duty nylon. Fastened elastic one side, velcro on the other.  
Set of 11. Letters on both sides

1	53317	36cm x 48cm	Medium
1	53318	40cm x 54cm	Large



## POLY NET BALL BIB

Polyester fine fabric. Fastened elastic one side, velcro on the other.  
Set of 7 letters on both sides.



2	53350	40cm x 54cm	Large
3	53351	40cm x 54cm	Large - Reversible

## LIGHT NYLON TRAINING BIB

Light duty nylon bibs with run through elastic.

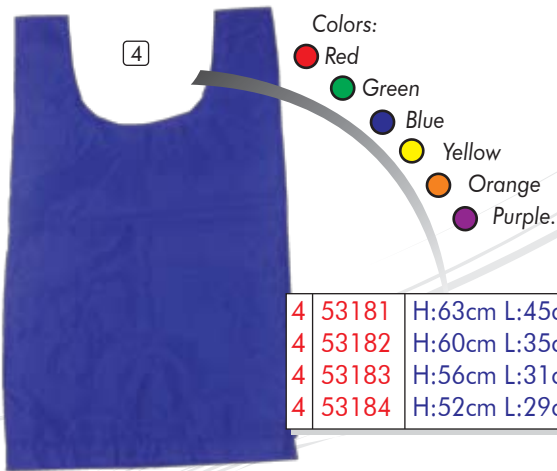

Colors:

- Red
- Green
- Blue
- Yellow
- Orange
- Purple.

4	53181	H:63cm L:45cm	Xlarge
4	53182	H:60cm L:35cm	Large
4	53183	H:56cm L:31cm	Medium
4	53184	H:52cm L:29cm	Small

## REVERSIABLE LIGHT NYLON TRAINING BIB

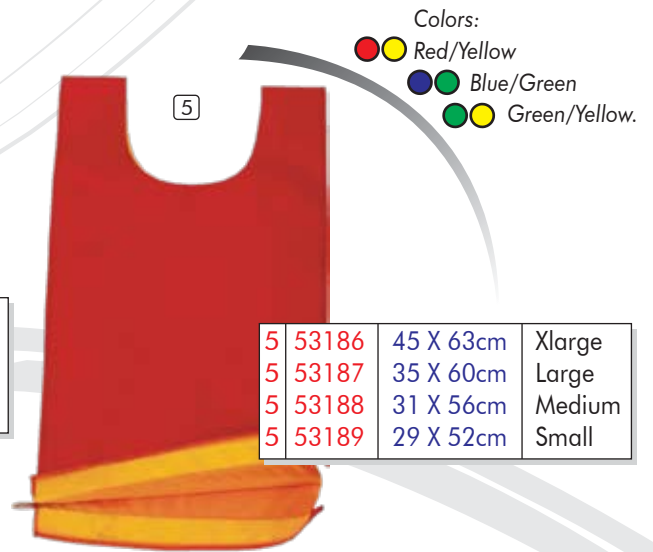

Colors:

- Red
- Yellow
- Blue
- Green
- Green/Yellow.

5	53186	45 X 63cm	Xlarge
5	53187	35 X 60cm	Large
5	53188	31 X 56cm	Medium
5	53189	29 X 52cm	Small

## LIGHT NYLON TRAINING BIB – Velcro closer.

Light duty nylon bibs, elastic on one side, elcرو on the others.



Colors:

- Red
- Green
- Blue
- Yellow
- Orange
- Purple.

6	53173	30 X 35cm	Small
6	53172	36 x 50cm	Medium
6	53171	40 x 55cm	Large

# Training Vests

## Vests



### Reversible Fluorescent Bibs

Fluorescent Orange/Yellow nylon fabric.



1	53201	Senior
1	53202	Junior
1	53203	Pupil

### SHORT

100% polyester.

- Colors:
-  Royal, Red,
  -  Black, Navy
  -  White, Green



2	53400	Size: XXXS, XXS, XS, S, M, L, XL, XXL
---	-------	---------------------------------------

### Pocket Training Bibs

Multi purpose nylon bib, suitable for A4 sheet in to transparent pocket.

3	53371	Size: 31x 55 cm
---	-------	-----------------

3





# Vests

# Training Vests

Wearing this brightly colored reflective vest makes your child more visible when playing, walking or bicycling as well as in crowded places. The vest is easy to put on and take off since it has a hook and loop fastener.

- Made of neon yellow 100% polyester
- 2 reflective strips, black trimming
- Adjustable Velcro straps



For Kids	1	53501	2-4 years	39 x 43cm
	1	53502	5-6 years	45 x 48cm
	1	53503	7-10 years	48 x 50cm

For Sports	1	53503	Medium	45 x 55cm
	1	53504	Large	48 x 60cm
	1	53505	XLarge	50 x 65cm

Hi-vis vest, ideal for wearing over pullover or jacket. Fluorescent with 50mm reflective tape - effective in daylight, night and poor visibility conditions.

- Neon yellow
- 100% polyester, self trimming.
- Velcro closer.



2	53511	Medium
2	53512	Large
2	53513	X-Large

## Hi Visibility Vest

100% Polyester Fabric, Reflective Tape 2 Body Bands & Braces Velcro. Neon yellow and orange. Strong and durable.

3	53521	Large
3	53522	X-Large



## CROSS REFLECTIVE VEST

100% neon orange polyester Fabric, Reflective strips across body & waist.

4	53529	Large
4	53530	X-Large



## REFLECTIVE VEST

100% Polyester Fabric, Reflective strips over shoulders and waist for all-round safety. One size fixed elastic and Velcro on others. Neon yellow. Conforms to safety standard.

5	53525	33 x 50cm	Small
5	53526		Medium
5	53527	36 X 60cm	Large



## REFLECTIVE MESH VEST

100% Polyester mesh fabric, Reflective strips over waist. Neon yellow.

6	53531	Small
6	53532	Medium
6	53533	Large





### Animal Bean Bags

Plastic pellets Filled, providing better hand conformity & more tactile feel.

Set of 6; one each of the primary and secondary colours with full of fun for throwing, handling & juggling activities.

1 60101 Frog - set of 6



### Utility Numbered Bean Bags

Phthalate Free vinyl Beanbags developed for inter-disciplinary activities, physical education and movement development. plastic pellets, double-stitched reinforced vinyl shells. Numbers appear in English, French and German.

2 60110 Set of 6 colours

3 60111 Set of 12 colours



### Food Bean Bags

Enjoy the health and multilingual benefits of these uniquely shaped beanbags.

Each includes phrases in English, German and French.

The colorful bags encourage discussions and healthy nutritional choices includes

one each of red tomatoes, yellow corn, blue salad bowl, green broccoli, violet onions, and orange carrots.

3 60112 Veggie Toss Bean Bags  
Set of 6 colors.



### Fruit Bean Bags

Fruit Salad beanbags enjoy the health and multi-lingual benefits of these uniquely shaped beanbag sets that include phrases in English, German and French.

The colorful bags encourage discussions about the important food group of fruits. Children learn better through movement.

Set of 6 includes: Red Cherries; Yellow Bananas; Blue Berries; Green Apples; Violet Plums; and Orange Oranges.

4 60113 Fruit Salad Bean Bags  
Set of 6 colors.





## Bug Bean Bags

Phthalate Free Soft vinyl bean bags are perfectly shaped for a kid's hand. Each bug is sequentially numbered 1-6, with the numeral and matching dot(s) on one side, and the matching word & color name on the other in English, French and German.

1 60115 Set of 6 colors



## Shapes Bean bags

Brightly colored set of bags is the perfect size for little hands to learn eight different shapes.

3 66118 Set of 8



## Alphabet Beanies

A 26 alphabet letters in upper and lower case, one on the front the other on the back. Vowels are in red and consonants are in blue. A perfect set for learning the alphabet and for letter games at home, schools. Comes in a carry bag.

2 60116 7x7 cm. Set of 26.



## Symbol Bean bags

Bright color Pvc bean bags having good educational learning tools.

4 66120 Set of 6



## Number Beanies

Set with numbers from 1-12.

Each bag has a number print on one side and DOTs print on the other. Comes in a practical storage bag. Ideal for Counting.

• colour range: blue, yellow, red, orange, purple and green  
5 66121 Set of 12.





### CONTROL PUNCHES with string

Orienteering Punches are available in three different series, A and B and C, Each series contains ten unique punches, giving a total of twenty different symbols offer an excellent way for orienteering teams and individuals to mark score cards when competing at all levels of the sport.

#### Features

- Each punch has a unique pin configuration.
- Box's of 10 different punches patterns.
- Two different sets providing 20 different punch patterns.
- Can be secured in location temporarily with string or permanently through two securing holes.
- Made from a strong red plastic.

1	80851	Series A
2	80852	Series B
2	80853	Series C

3 models

1

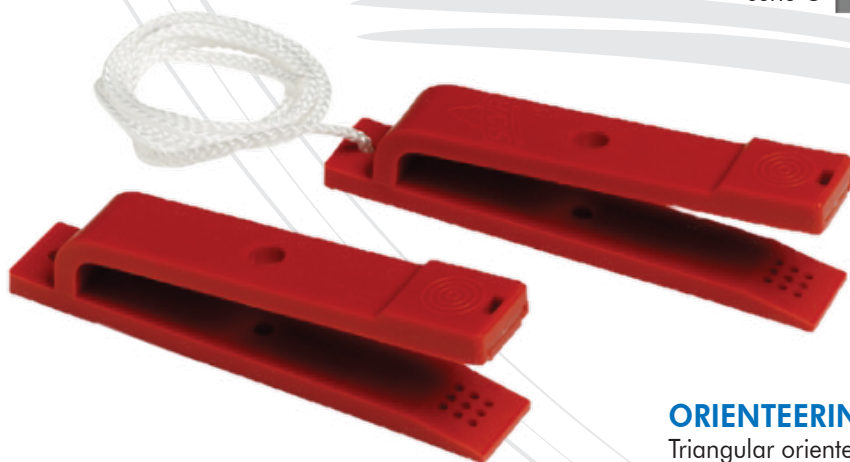

### ORIENTEERING MARKER

Triangular orienteering markers orange / white with string & plastic fixing hook. Strong nylon.

2	80802	150 x 150 mm
3	80801	300 x 300 mm with inside pocket 10 x 6cm
4	80803	60 x 60 mm Mini

2



3



4





# Slalom Poles

# Agility Training

## BASIC AGILITY POLE

- 1 **54501** Sturdy 25mm Yellow PVC poles, 15cm metal tip. 1.60M
- 2 **54502** 25mm Yellow PVC pole with spring at bottom & round metal plate. 1.60M
- 3 **54503** – As above but IN TWO pieces (folding).
- 4 **54504** 25mm Yellow PVC pole SPRING in center and at bottom & round metal plate. 1.60M
- 4 **54505** 25mm PVC pole with CENTER SPRING. 1.60M

Each Pole end is provided with a cover & rivet to have extra strong.

1



2

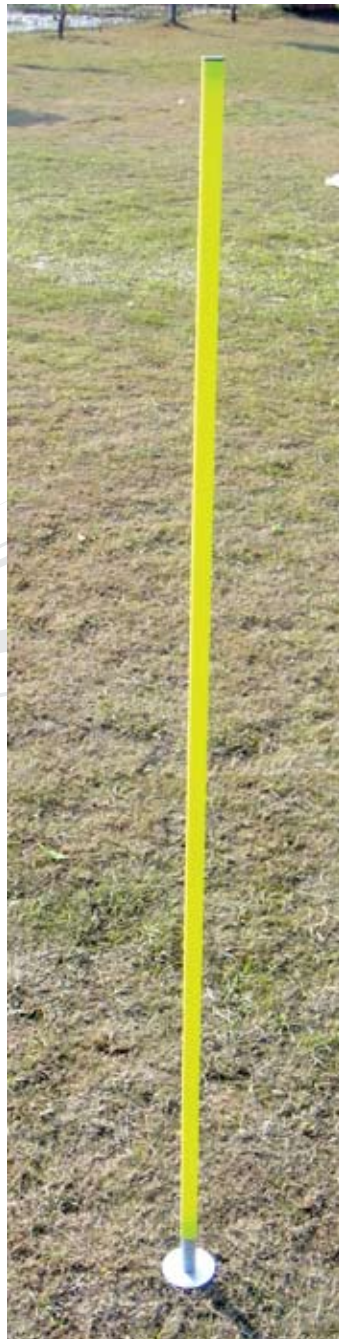

3



4

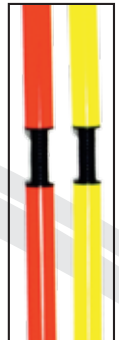



Highly visible PVC poles for driving into the ground to hold poles securely in place during outdoor activities. popular training aid for all sports.

### RUBBER BASE AGILITY POLE

Sturdier, 25mm PVC poles with rubber encased flexible spring base provides flexibility and immediate response, 15cm metal tip.

- 1 54511 Single construction – 1.70M, with 15cm metal tip.
- 1 54512 Two-piece construction for easy transportation. 1.70M

### ELEMENTARY AGILITY POLE

- 2 54521 Sturdy 30mm PVC poles, 15cm metal tip. 1.60M
- 3 54522 Sturdy 30mm PVC poles, two pieces construction, 15cm metal tip. 1.60M
- 4 54525 Sturdy 30mm PVC poles with bottom spring, 15cm metal tip. 1.60M
- 5 54526 Sturdy 30mm PVC poles with center spring, 15cm metal tip. 1.60M

*Hint*

### AGILITY TRAINING

Agility Training helps individuals learn to quickly change directions without losing speed, balance or body control. Agility training improves the ability to stop and start suddenly and to quickly change directions during sport or physical activities.

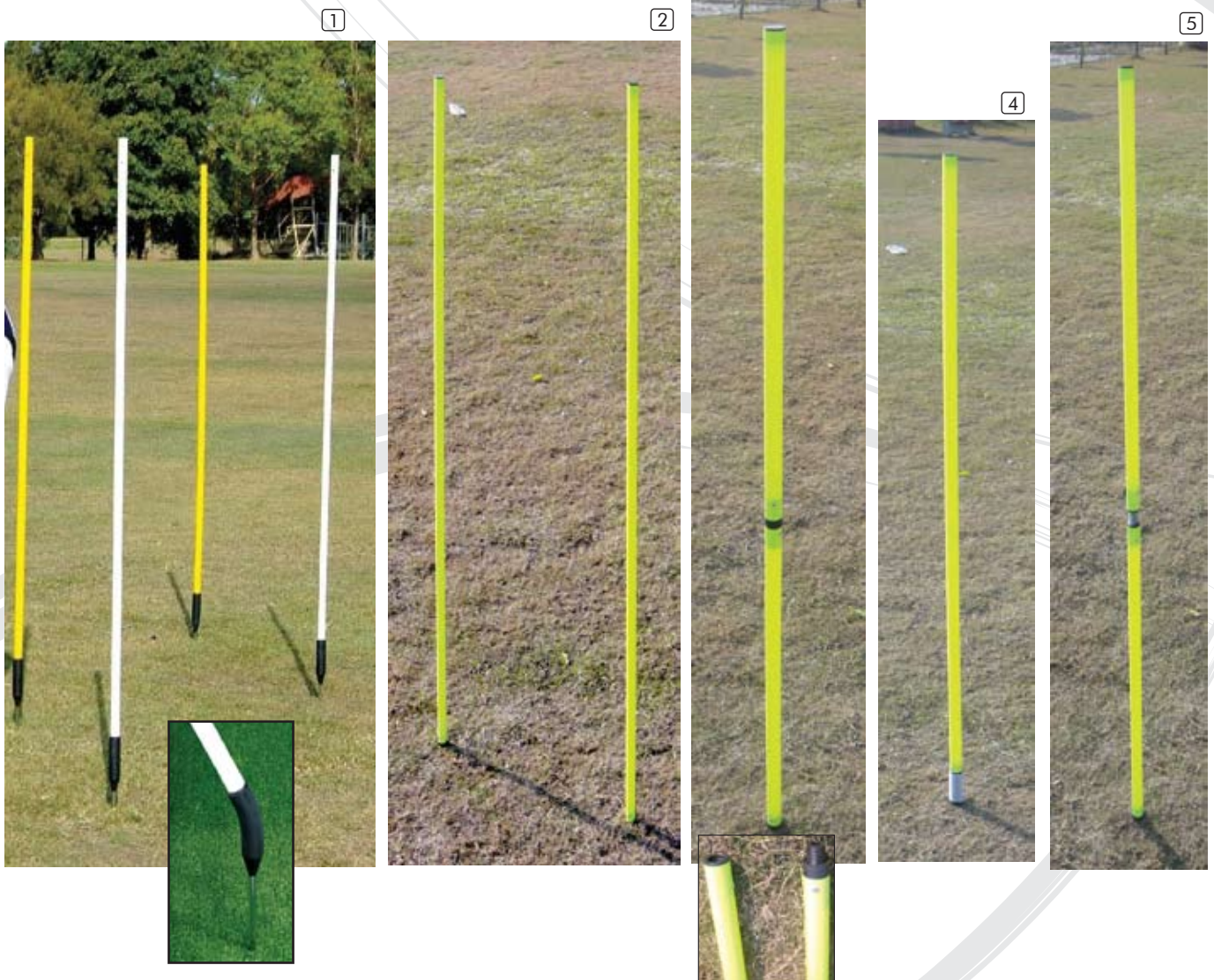





### 3-HOLE MULTI DIRECTION RUBBER BASE FOR AGILITY

Multi direction rubber base allows Agility poles for use in Indoor and outdoor. Multi holes allows poles to be used vertically or on an angle. Poles not included.

- 1 54555 Heavy duty rubber base. Dia: 23cm. Weight: 1.4kg. Suits Gisco Agility Pole (2-041), (44-025).

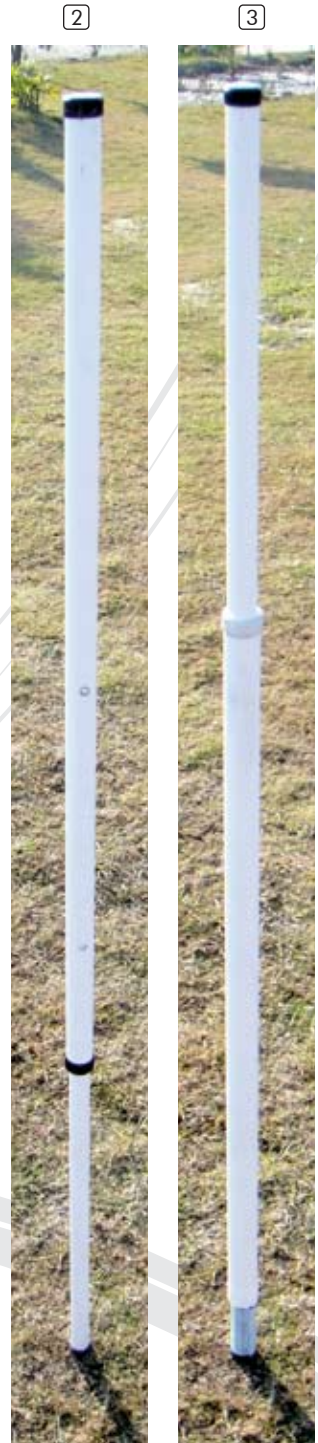

### TELESCOPIC AGILITY POLE

Telescopic Slalom Poles, these poles are adjustable from 120 cm to 170 cm in 4 different Heights (120 cm, 140 cm, 160 cm, 170 cm). Highly versatile pole as compared to the regular slalom poles. Advantage of these agility poles are packed at the lowest height to save transportation and space.

- 2 54561 Dia: 40mm upper pole - 32mm inner pole.
- 3 54562 Dia: 32mm upper pole - 25mm inner pole with bottom spring and adjustable in any height with center locking system.

### AGILITY POLE BASE

- 4 54300 Heavy duty plastic base, suitable for 30mm poles.





### AGILITY POLE – without metal tip.

- 1 **54571** Single piece construction. Ø 25mm Length: 1.60M
- 1 **54572** Two piece construction. Ø 25mm Length: 1.60M
- 1 **54574** Single piece construction. Ø 25mm Length: 1.70M
- 1 **54575** Two piece construction. Ø 25mm Length: 1.70M
- 1 **54576** Single piece construction. Ø 30mm Length: 1.70M
- 1 **54577** Two piece construction. Ø 30mm Length: 1.70M



### AGILITY POLE CARRY BAG

- 2 **54530** suitable for 10 poles folding for 54522, 54512, 54503.  
Size: 120cm x 17.50 diameter.
- 3 **54531** Suitable for 10 poles for single construction poles.



### MARKING DISC

Non-slip rubber disc for indoor use. Can be used as a marker for sectioning. Consisting of 12 red and 12 yellow, including mounting. Dia 150mm.

Features:

- A non-toxic and environmentally friendly soft disc.
- Reduces injury and slippery in all indoor sports.
- Is not in the way during exercise. Do not disturb the player's technical performance.
- Don't blow away in strong winds.

- 4 **54180**

Colors:

- Red
- Yellow
- White
- Blue
- Green
- Violet
- Orange

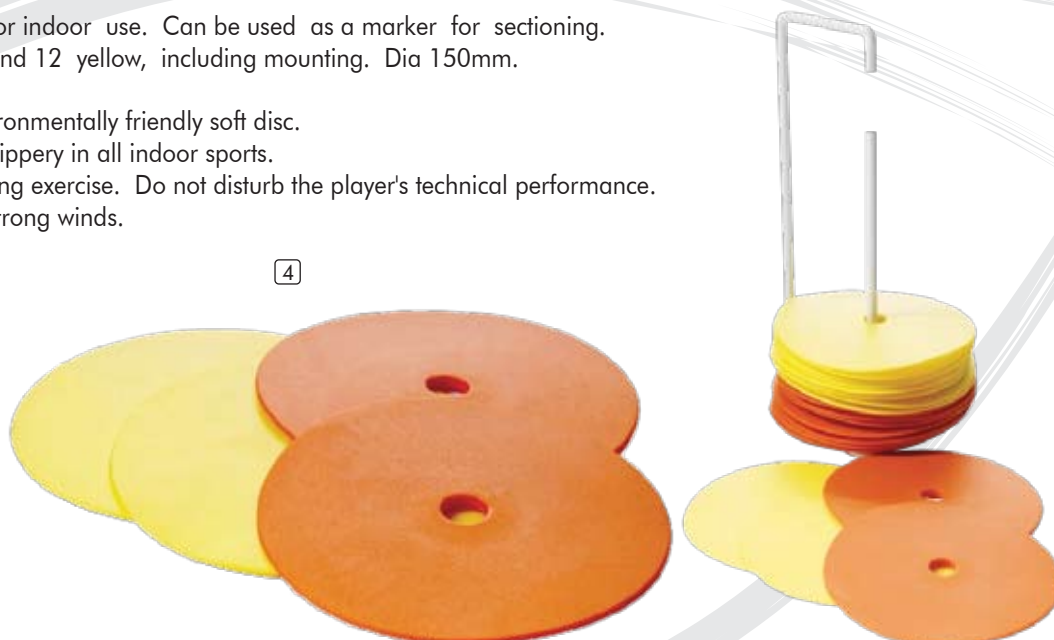



## Base Plate/Sockets

# Floor Sockets

### Ground cover with frame

Plastic cover with aluminum frame.

- 1 77001 150mm
- 1 77002 210mm
- 1 77003 275mm
- 2 77004 350mm

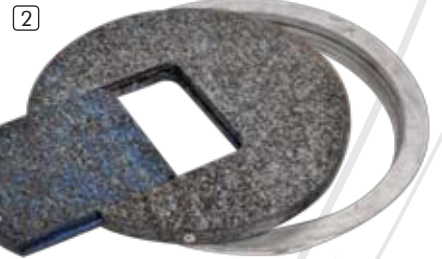

### Safety screw with bottom Plate

With internal thread M-12, 76 mm diameter, 2 mm thick, for installation in the upper floor. without screws.

- 3 77011 Safety screw and Bottom plate.
- 4 77012 Bottom plate only
- 5 77013 Safety screw short M12 x 30 with soft rubber top.
- 5 77014 Safety screw short M12 x 90 with soft rubber top.



### Floor Sockets

Suitable for volleyball posts and other sports.

- 6 77031 1-7/8" brass floor sockets with lid.
- 7 77032 Lid only

### Floor ring and Base Plate

- 8 77041 Floor Ring OD 200mm
- 8 77042 Floor Ring OD 140mm
- 8 77043 Floor Ring OD 125mm
- 8 77044 Floor Ring OD 100mm
- 8 77045 Floor Ring OD 80mm
- 9 77046 Floor Base plate SOLID steel (Lock) 150mm
- 9 77047 Floor Base plate SOLID steel (Lock) 98mm
- 9 77048 Floor Base plate SOLID steel (Lock) 98mm
- 9 77048 Floor Base plate SOLID steel (Lock) 80mm
- 9 77048 Floor Base plate SOLID steel (Lock) 55mm

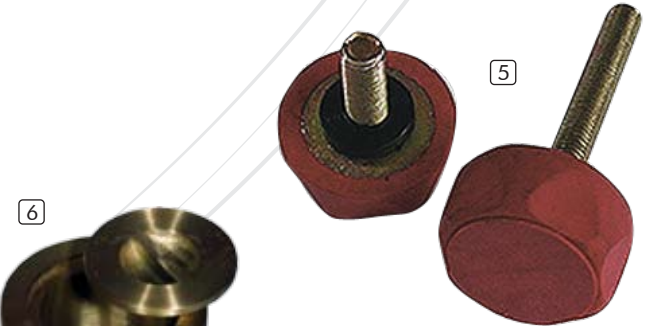

### Brass Floor ring and plate

- 10 77051 Brass floor Ring OD 170mm + base plate 135mm

